



Scan QR Code
with your smart phone



TALC INDUSTRIES
ONE STOP FOR MEDICAL EQUIPMENT

VETERINARY Catalogue
2022 - 23
INSTRUMENTS

www.talcindustries.com



TALC INDUSTRIES is a well-respected, successful family owned, manufacturing and running business, established in 2004. We have been supplying the veterinary industry globally since 2006.

In line with our strategic plans and building own our success in the veterinary market. TALC INDUSTRIES are proud to present our new addition of our high-end veterinary catalog with our updated range of equipment for equine, cattle, pigs and small ruminants.

This bespoke catalog brings to you a superb array specialist veterinary products. We always strive to offer our customers the very best products in order to facilitate excellent and efficient animal healthcare consequently.

We have closely with Veterinary specialists across the world to bring you a range of products, not just to your clinical needs what also to suit your pocket.

A Key Objective with our new Veterinary range is to make life easier for the veterinary clinical team. To this end we have included additional sections with in our catalog.

We hope you will find most of what you need in the catalog however the TALC INDUSTRIES range of products is extensive so please also check out our website www.talcindustries.com. Be sure to contact us for further guidance own our products.

Muhammad Tayyyab
Managing Partner

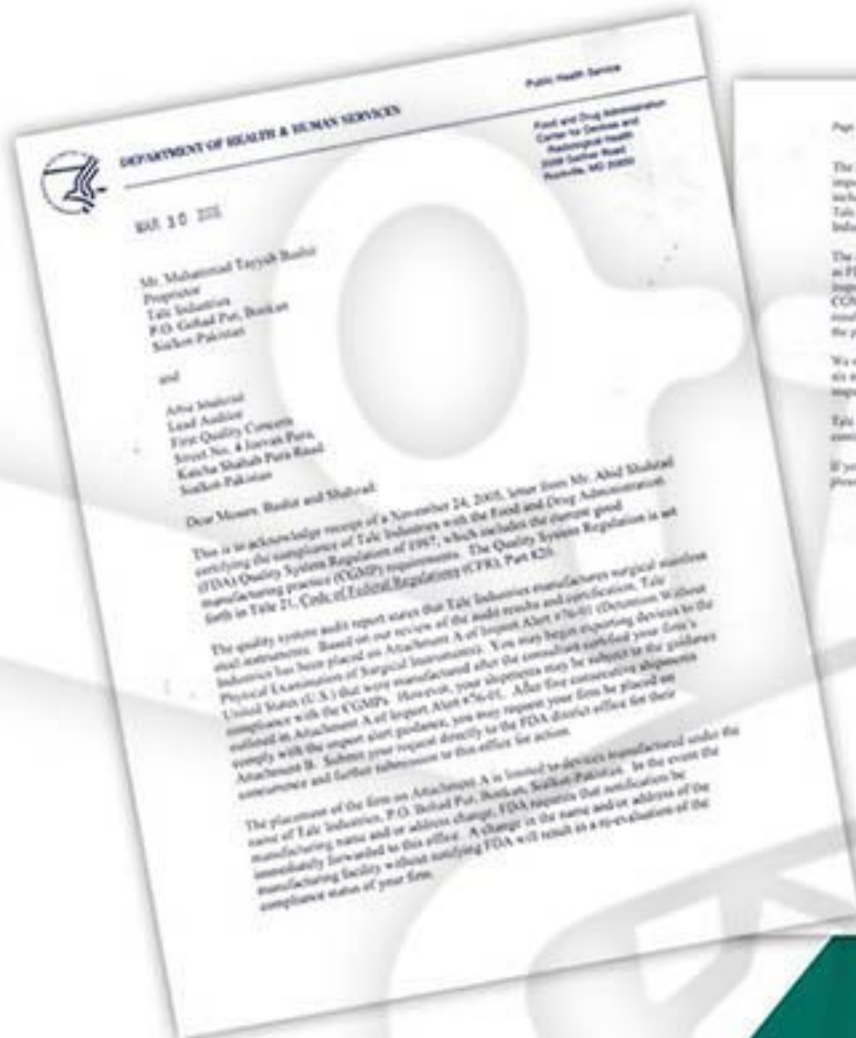
CERTIFICATIONS



CERTIFICATIONS



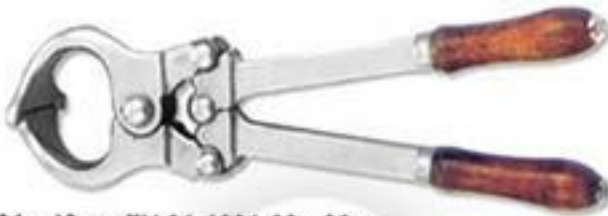
TALC INDUSTRIES
ONE STOP FOR MEDICAL EQUIPMENT



CGMP
(FDA-USA)



CE
Approved



TV-01-1001-01 - 40cm TV-01-1001-03 - 30cm
TV-01-1001-02 - 49cm TV-01-1001-04 - 36cm
Bloodless Castrator
(For Bulls and Big Animals)



TV-01-1006
Castrator Heavy Duty with pin



TV-01-1002-01 - 40cm TV-01-1002-03 - 30cm
TV-01-1002-02 - 49cm TV-01-1002-04 - 36cm
Bloodless Castrator
(For Bulls and Big Animals)



TV-01-1007-01 - 23cm
TV-01-1007-02 - 30cm
De White Emasculator S.S



TV-01-1003 - 23cm
Bloodless Castrator
(For Lambs and Rabbit)

TV-01-1008-01 - 19cm
TV-01-1008-02 - 23cm
TV-01-1008-03 - 27cm
Emasculator Cut The Tail
and Crushes The Blood Vessel

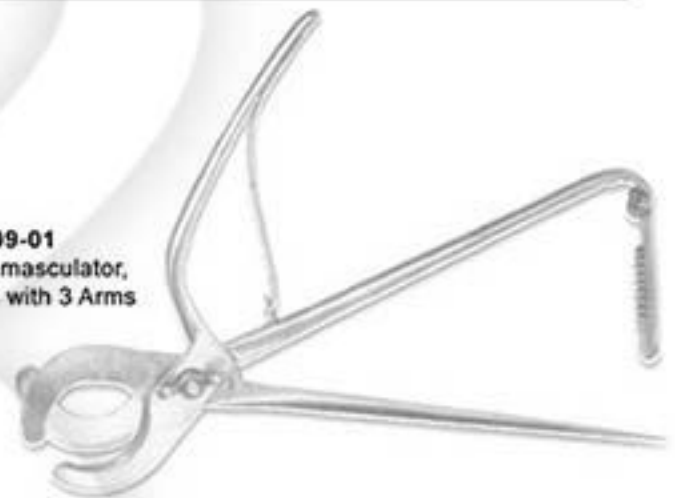


TV-01-1004 - 23cm
Bloodless Castrator
(For Lambs and Rabbit)

TV-01-1009-01
Reimers Emasculator,
for Horses with 3 Arms

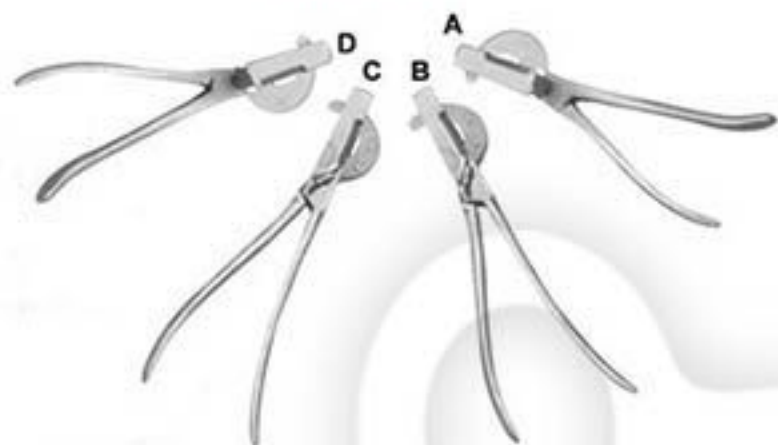


TV-01-1005
Heavy Duty Marking
Ring Applicator



TV-01-1010
Hoof Pressor
Heavy Duty





TV-02-1011
A-Castration Emasculator Instruments
B-WHITE Emasculator 12"
C-PLAIN Emasculator 12"
D-Small White Emasculator



TV-02-1015
Heavy Duty Bull
Holder with Chain



TV-02-1012
Bull Holder with Spring



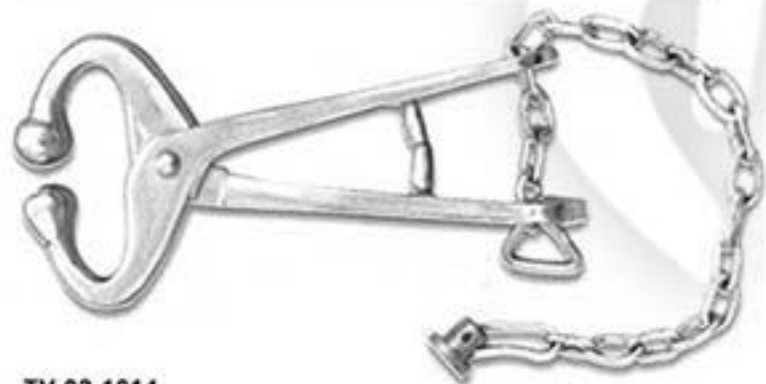
TV-02-1016
Heavy Duty Bull
Holder without chain



TV-02-1013
Bull Holder
with Side Gripe



TV-02-1017
Bull Holder Harm's with
Rowel Slide



TV-02-1014
Heavy Duty Bull
Holder with chain



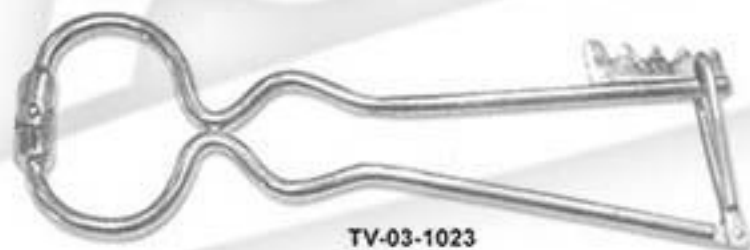
TV-02-1018
Bull Holder with Spring



TV-03-1019
Bull Holder with Spring



TV-03-1020
Bull Holder with Spring



TV-03-1023
Bull Holder



TV-03-1021
Automatic Lock Easily
Released Bull lead, Aluminum



TV-03-1024
Bull Holder with chain



TV-03-1022
Bull Holder Continental
Tong Pattern, 43cm



TV-03-1025
Krey-Schottler



TV-04-1026
Bull Nose Ring
Applicator with
Vertical opening Delivered
With A Break-off Screw



TV-04-1030
Bull Ring Halter



TV-04-1031-01 - 55mm (5.5cm)
TV-04-1031-02 - 59mm (5.9cm)
TV-04-1031-03 - 65mm (6.5cm)
TV-04-1031-04 - 76mm (7.6cm)
TV-04-1031-05 - 88mm (8.8cm)
Bull Ring Stainless Steel



TV-04-1027
Bull Nose Ring
Applicator For Bull Rings

TV-04-1032-01 - 55mm (5.5cm)
TV-04-1032-02 - 59mm (5.9cm)
TV-04-1032-03 - 65mm (6.5cm)
TV-04-1032-04 - 76mm (7.6cm)
TV-04-1032-05 - 88mm (8.8cm)
Bull Ring Chrome Plated



TV-04-1028
With Pig Staples
Applicator Made of Aluminium
With Adjustment Screw



TV-04-1029
Milk Sucking Preventor Plier
Available in Red Colour Also



TV-04-1033-01 - 55mm (5.5cm)
TV-04-1033-02 - 59mm (5.9cm)
TV-04-1033-03 - 65mm (6.5cm)
TV-04-1033-04 - 76mm (7.6cm)
TV-04-1033-05 - 88mm (8.8cm)
Bull Ring Brass



TV-05-1039-02
30mm



TV-05-1039-04
40mm



TV-05-1039-01
20mm



TV-05-1039-03
20mm



TV-05-1040
NOSE RING APPLICATOR
Make pig ringing quick, easy and painless
Rings go between nostrils. Length 10"



TV-05-1044
Hoof Tester



TV-05-1041
SMOOTH PIG RING APPLICATOR
Send cast stainless steel
snout pig ring applicator.



TV-05-1045
Round Hoof Tester



SET OF 100



Clips

Clips Size

- TV-05-1042-01** No. 3
- TV-05-1042-02** No. 4
- TV-05-1042-03** No. 5
- TV-05-1042-04** No. 6



TV-05-1046
Flat Hoof Tester



TV-05-1043
Hoof Puncher



TV-05-1047
Flat Hoof Tester



TV-06-1048
Tubing Forcep Roller



TV-06-1055



TV-06-1049
Tube Forceps Roller



TV-06-1056



TV-06-1050



TV-06-1057



TV-06-1051



TV-06-1052



TV-06-1058
Marking Ring Applicator
Plastic Made



TV-06-1053



TV-06-1054



TV-06-1059
Marking Ring Applicator
S.S Finish



TV-07-1060



TV-07-1061



TV-07-1062



TV-07-1063

TEAT TUMOR EXTRACTORS



TV-07-1064



TV-07-1065



TV-07-1066



TV-07-1067



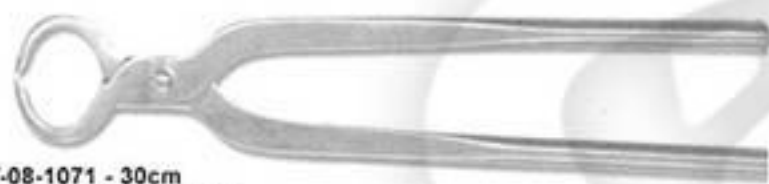
TV-08-1068-01 - 30cm
TV-08-1068-02 - 32cm
Hoof Tester
Round Large



TV-08-1069-01 - 30cm
TV-08-1069-02 - 33cm
Shoe Puller



TV-08-1070-01 - 30cm
TV-08-1070-02 - 36cm
TV-08-1070-03 - 38cm
Diamond Farrier
Naippers 15"



TV-08-1071 - 30cm
Shoe Puller to Grab Hold
of the Shoe Removal



TV-08-1072 - 33cm
Diamond Shoe Puller & Spreader
Round Knobs on of Handles



TV-08-1073-01 - 33cm
TV-08-1073-02 - 38cm
Black Steel Crocodile Piler with
Plastic Coated end (clincher)



TV-08-1074-01 - 33cm
TV-08-1074-02 - 38cm
Black Steel Crocodile
Piler (clincher)



TV-08-1075 - 32cm
Diamond Nail Puller



TV-08-1076-01 - 30cm
TV-08-1076-02 - 36cm
TV-08-1076-03 - 38cm
Nail Nipper



TV-08-1077-01 - 30cm
TV-08-1077-02 - 36cm
TV-08-1077-03 - 38cm
Professional Hoof Nipper
With Wide Opening



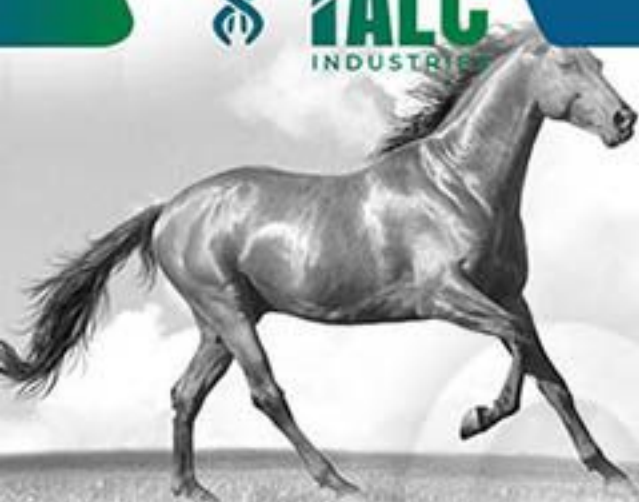
TV-08-1078
Diamond Farrier
Clincher



TV-08-1079



TV-08-1080-01 - 30cm
TV-08-1080-02 - 36cm
TV-08-1080-03 - 38cm
Fine quality steel hoof nipper with cushion grip
handle. Length 15". Also available in
12", 14" c/s.



TV-09-1081
Clinch Cutter on one end pritchel on opposite end s/s.



TV-09-1082
Clinch Cutter on one end pritchel on opposite end, powder coated c/s.



TV-09-1083
Farrier Hammer



TV-09-1084
Foot Rotshear with lock pin



TV-09-1085
Foot Rot shear



TV-09-1086



TV-09-1087
Sheep Hoof Cutter



TV-09-1088
Heavy Duty Hoof
Claw Cutter with
Interchangeable Blades



TV-09-1089



TV-09-1090
Stainless Steel Hoof Scraper



TV-09-1091
Stainless Steel Hoof Scraper



TV-10-1092
Hoof Knife, Plastic
Handle with Cap



TV-10-1093
Hoof Knife, Wooden
Handle with Double Edges



TV-10-1094
Hoof Knife, Wooden
Handle with Left Edge



TV-10-1095
Hoof Knife, Wooden
Handle with Right Edge



TV-10-1096
Hoof Knife, Wooden
Handle with Double Edge



TV-10-1097
Hoof Knife with
Different Blades



TV-10-1098
Hoof Knife, Wooden
Handle with Left Edge



TV-10-1099
Hoof Knife, Wooden
Handle with Double Edge



TV-10-1100
Hoof Knife, Wooden
Handle with Right Edge



TV-10-1101
Hoof Knife, Plastic
Handle with Right Edge



TV-10-1102
Hoof Knife, Plastic
Handle with Left Edge



TV-10-1103
Hoof Knife, Plastic
Handle with Double Edge



TV-10-1104
Egg But Knife



TV-11-1105
Hoof Picks



TV-11-1106
Sheep Hoof Knife



TV-11-1107
Cow Hoof Knife
with Wooden Handle



TV-11-1108
Sheep Hoof Knife



TV-11-1109
Rasp without Handle



TV-11-1110
Hoof Rasps



TV-11-1111
Hoof Rasps



TV-11-1112
Hoof Rasps



TV-11-1113
Hoof Rasps



TV-11-1114
Hoof Rasps



TV-11-1115
Hoof Rasps

BEHORNER



TV-11-1116
Rasep Barness Dehorner
with Wooden Handle



TV-11-1117
Rasep Barness Dehorner
with Metallic Handle and Also
available in wooden handle



TV-11-1118
Rasep Barness Dehorner
with Metallic Handle and Also
available in wooden handle



TV-12-1120
Clipper Both Sided
Thin & Wide Teeth



TV-12-1121
Hand Sheep Clipper
with wooden handle



TV-12-1122
Hand Sheep Clipper



TV-12-1123
Hand Sheep
Clipper



TV-12-1124



TV-12-1125



TV-12-1126
Hand Sheep Clipper
with wooden handle



TV-12-1127
Aluminium Mane Comb
with wooden handle



TV-12-1128
Aluminium
Mane Comb



TV-12-1129
Aluminium
Mane Comb



TV-12-1130
Aluminium Jockey
Mane Comb



TV-12-1131
Sheep Shears



TV-12-1132
Sheep Shears



TV-13-1133
Mini Hog Catcher
Rubber Grips



TV-13-1134
Pig Holder S.S



TV-13-1135
Pig Holder S.S



TV-13-1136
Hog Catcher with
Rubber Grips



TV-13-1137
Pig Catcher



TV-13-1138
Calf Head Snare



TV-13-1139



TV-13-1140
Pig / Hog Holder-86cm



TV-13-1141
Pig / Hog Holder



TV-13-1142
Pig / Hog Holder



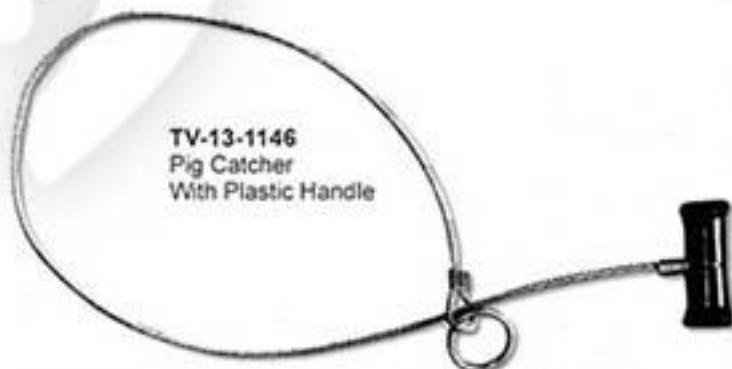
TV-13-1143
Balling Gun with Plastic Head
with or without spring



TV-13-1144
Calving Forceps, S.S



TV-13-1145
Pig Catcher, S.S



TV-13-1146
Pig Catcher
With Plastic Handle



TV-14-1147
Pig Catcher



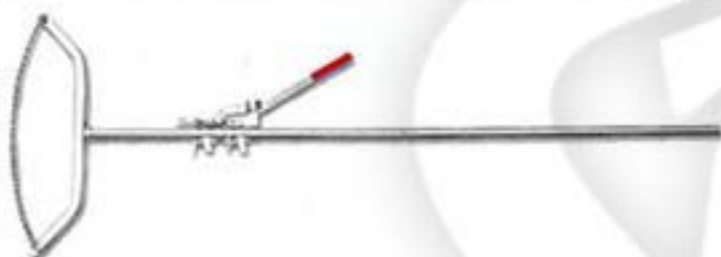
TV-14-1152
Obstetric Chain 30", S.S or N.P



TV-14-1148
Aluminium Mini
Hog Catcher



TV-14-1153
Obstetric Chain
60", S.S or N.P



TV-14-1149
Calf Puller



TV-14-1154
Lambing Aid Plastic



TV-14-1150
Calving Assist
Forceps S.S



TV-14-1155
Wire Handle



TV-14-1151
Obstetric Forceps for
Pig About 52cm Long, S.S



TV-14-1156
Wire Handle



TV-15-1160
Ear Notcher -A- type



TV-15-1161
Ear Notcher -
A- type



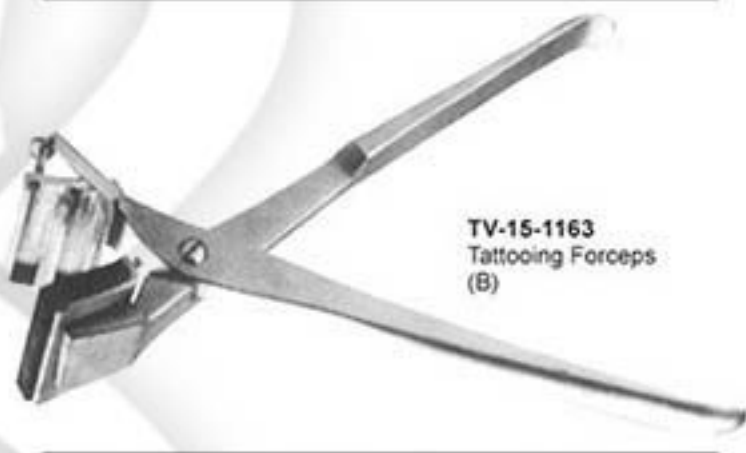
TV-15-1157
Tag Applicator Plier



TV-15-1162
Tattooing Forceps (A)



TV-15-1158
Ear Notcher
with lock



TV-15-1163
Tattooing Forceps
(B)



TV-15-1159-01

TV-15-1159-02

TV-15-1159-03

TV-15-1159-04

TV-15-1159-05

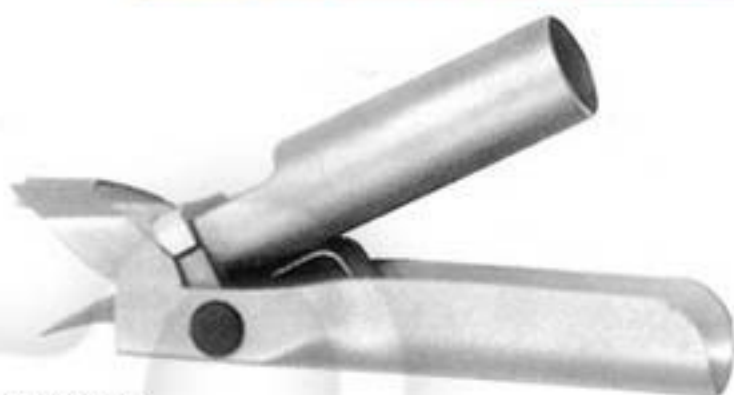
TV-15-1159-01-05
Ear Notcher S.S
Design in the Centre of the ear



TV-15-1164
Tattooing Numbers
02-9



TV-16-1165
Tattooing Forceps (E)



TV-16-1172
Gas Tail Docker



TV-16-1166
Trocar



TV-16-1173-01



TV-16-1173-02



TV-16-1173-03



TV-16-1167
Trocar



TV-16-1173-04



TV-16-1173-05



TV-16-1168
Trocar



TV-16-1169
Trocar



TV-16-1174
Pig Tooth Cutter
13cm



TV-16-1170
Trocars -A- with Plastic Handle



TV-16-1171
Trocars -B- S.S



TV-16-1175
Pig Castration Forceps



TV-17-1176



TV-17-11780



TV-17-1177
Tag Puncher



TV-17-1181-01
O.B Handle



TV-17-1181-02
O.B Handle



TV-17-1178



TV-17-1182
Eye Hook S.S



TV-17-1179



TV-17-1183-01 - 18cm
TV-17-1183-02 - 23cm
Eye Hook S.S



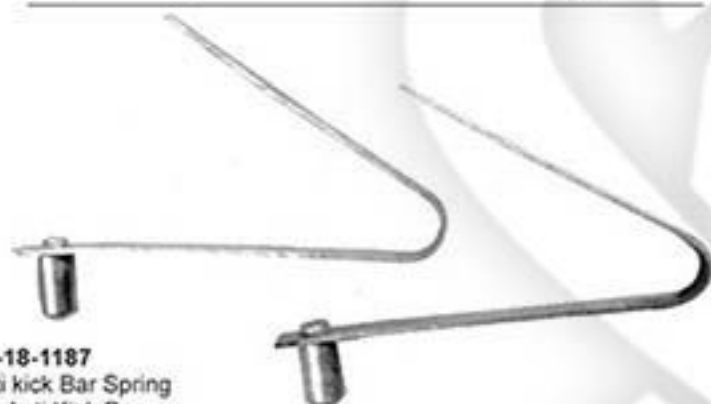
TV-18-1184
Anti kick Clamp



TV-18-1185
Anti kick Clamp



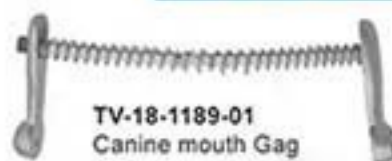
TV-18-1186
Anti kick Bar Spring
For Anti Kick Bar



TV-18-1187
Anti kick Bar Spring
For Anti Kick Bar



TV-18-1188
Crook Head For Ig



TV-18-1189-01
Canine mouth Gag
17cm



TV-18-1190-01
Cat Mouth Gag
7.5cm



TV-18-1189-02
Canine mouth Gag
14cm



TV-18-1190-02
Cat Mouth Gag
5.5cm



TV-18-1189-03
Canine mouth Gag 11cm



TV-18-1190-03
Cat Mouth Gag
2.7cm



TV-18-1189-04
Canine mouth Gag 8cm



TV-18-1191
Pit bull Ear Clamp



TV-18-1192
Schnauzer Ear Clamp



TV-18-1193
Dober Mal Ear Clapm



TV-18-1194
Dog Ear Cropping Guide Set



TV-19-1195
Shepherd's Crook Neck Model
135cm



TV-19-1196
Shepherd's Crook Leg Model
95cm



TV-19-1197
Sheep Cuff



TV-19-1198
Milk Sucking Preventor
with Spring Made of
Aluminium & Having
2 Modles with or
without Spikes



TV-19-1199-01
Plastic Milk Sucking Preventor
with Different Colour with
Different Sizes



TV-19-1199-02
Plastic Milk Sucking Preventor
with Different Colour with
Different Sizes



TV-19-1200



TV-19-1201
Spiked Swingram
Preventor Made of Metal with
Adjustment Nut



TV-19-1202
Spiked Swingram Milk Sucking
Preventor Made of Metal with
Adjustment Nut



TV-19-1203
Mouth Speculum
with leather straps



TV-20-1204
Stomach Pump



TV-20-1205
Stomach Pump



TV-20-1205-01
Balling Gun, Upto 6 Boluses
Can Be Administrated Per Animal,
Pistol Grip Handle



TV-20-1206
Balling Gun with Metal Head
with or without Spring



TV-20-1207
Balling Gun with Rubber Head
with or without Spring



TV-20-1208
Balling Gun with Plastic Head
with or without Spring



TV-20-1209
Balling Gun with Metal Head
with or without Spring



TV-20-1210
Syringes



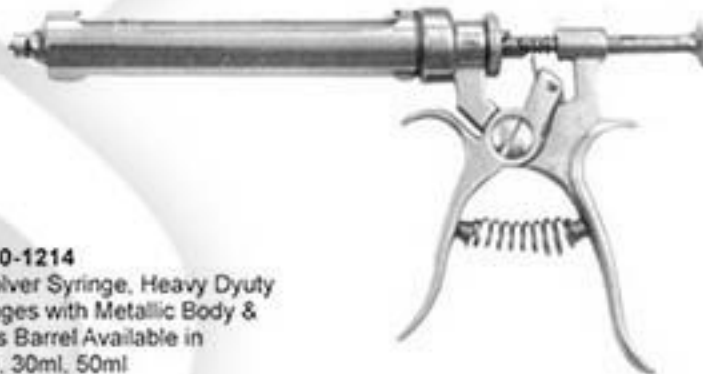
TV-20-1211
Syringes



TV-20-1212
Syring with Plastic Handle



TV-20-1213
Revolver Syringe, Heavy Dyuty
Syringes with Metallic Body &
Glass Barrel Available in
10ml, 30ml, 50ml



TV-20-1214
Revolver Syringe, Heavy Dyuty
Syringes with Metallic Body &
Glass Barrel Available in
10ml, 30ml, 50ml



TV-20-1215
Syringes



TV-21-1219
Veterinary syringe



TV-21-1216
Veterinary syringe



TV-21-1220
Veterinary syringe



TV-21-1217
Veterinary syringe



TV-21-1221
Veterinary syringe



TV-21-1218
Veterinary syringe



TV-21-1222
Veterinary syringe



TV-22-1223

Wolf Tooth Elevator / Extractor

They Come in a set of two or can be purchased individually. Each head is made of surgical stainless steel and each handle made with lightweight aluminum. Both are made to precise measurements and standards of our company. Head come in two diameters 5/6" and 3/8"



TV-22-1227
Stomach flexible Tube
6 Feet



TV-22-1224

Cow Magnet 1/2" x 3" long

This Not-toxic, non-corrosive, cow magnet is the pinnacle of what the industry has come to expect. Made of the highest grade materials. This magnet has been the choice of many dairymen and veterinarians over the years. wt 3.0 oz.



TV-22-1228
Saw Handle



TV-22-1225
Catheter (Female)



TV-22-1225-01
Catheter (Male)



TV-22-1226
Stomach magnet
Throwing Gun



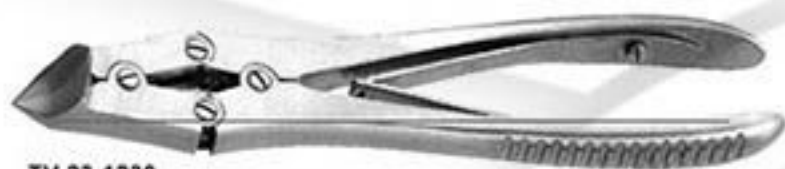
TV-23-1234
Professional Toe Nail
Nipper 16cm Double Action,
Stainless Steel (Satin Finish)



TV-23-1229
Professional Toe Nail Nipper 16cm
Compound Action,
Stainless Steel (Satin Finish)



TV-23-1235
Professional Toe
Nail Nipper



TV-23-1230
Professional Toe Nail Nipper 16cm
Compound Action, Stainless Steel
(Satin Finish)



TV-23-1236
Professional Toe
Nail Nipper



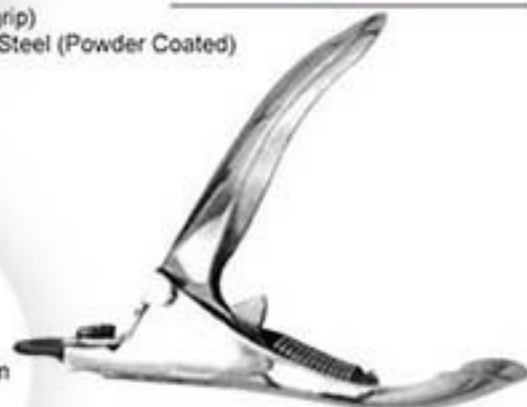
TV-23-1231
Professional Toe
Nail Nipper



TV-23-1237
Nail Profiler (with grip)
14.5cm, Stainless Steel (Powder Coated)



TV-23-1232
Professional Toe
Nail Nipper



TV-23-1238
Nail Profiler 14.5cm
Stainless steel



TV-23-1233
Toe Nail Nipper 14cm
Box joint, Double Spring
Stainless steel (Stain Finish)



TV-23-1239

TV-23-1239-01



TV-24-1240
Snake Holder Stick
(Available in any colour)



TV-24-1242
Snake Holder Stick
(Available in any colour)



TV-24-1243
Snake Holder Stick
(Available in any colour)



TV-24-1241
Snake Holder Stick
(Available in any colour)



TV-24-1244
Snake Holder Stick
(Available in any colour)



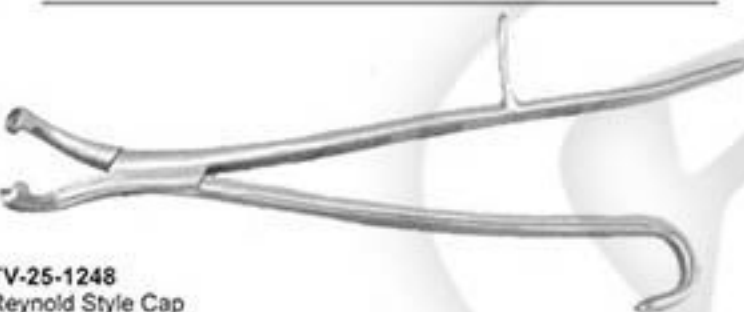
TV-24-1245
Snake Holder Stick
(Available in any colour)



TV-25-1246
Mouth Specium Hussmann,
Model with leather straps,
or Nylon Straps



TV-25-1247
Tooth Float set



TV-25-1248
Reynold Style Cap
Extractors, 17" s/s



TV-25-1249
Simple Joint Stainless
Steel Molar Spreader



TV-25-1250
Simple Joint Stainless
Steel Molar Forceps



TV-25-1251
Cap, Incisor
s/s 12"



TV-25-1252
Molar Extractors,
s/s 15"



TV-25-1253
Incisor & Canine Cutter
s/s, 10"



TV-25-1254
Incisor Forceps, 10"



TV-25-1255
Liautard Style
Forceps, 10" S.S



TV-25-1256
incisor cap and wolf
tooth Forceps, 7" S.S



TV-26-1261
Tooth Forceps



TV-26-1262
Scalar



TV-26-1257
Tooth Forceps



TV-26-1263
Elevator



TV-26-1258
Tooth Forceps



TV-26-1264
Small Elevator



TV-26-1265
Left Elevator
3mm Head



TV-26-1259
Single Joint
Rongeur 7" s/s



TV-26-1266
Straight Elevator
3mm Head



TV-26-1260
Tooth Forceps



TV-26-1267
Right Elevator
3mm Head



TV-27-1268
Farrie Tolls kit
1 x Hoof Rasps
1 x Farrier Hammer
1 x Clinch Cutter
1 x Hoof Knife
1 x Hoof Tester
1 x Hoof Cutting Nipper
1 x Artificial Leather Case
for instruments.



TV-27-1269
Farrie Tolls kit
1 X Hoof Rasps
1 x Hoof Nipper
1 x Farrier Clincher
1 x Hoof Puller
1 x Farrier Hammer
2 x Hoof Knives
1 x Hoof Pick
1x Pouch for Instrument Storage



TV-27-1270
Burgees wolf tools Elevator kit
1 x Gripping Handle
1 x 5/16" Tip
1 x 3/8" Tip
1 x 1/2" Tip
1 x Straight Extension
1 x Offset Extension
1 x Pick
1 x Pick
1 x Pick
1 x Pouch

Handle

Extension
Straight

Extension
Offset

Pick

Pick

5/16"
Tip

3/8"
Tip

1/2"
Tip



TV-27-1271
Incisor & Wolf Tooth Elevator kit
3 x Dental Incisors, Straight, Up
Curved, Down Curved.
3 x Dental Elevators, Straight, Up
Curved, Down Curved.



TV-27-1272
Equine Dental Kit
1 X Dental Mouth Mirror 2" Dia 16" long
1 X Dental Needle Pick 1" 17" Long
1 X Dental Scaler 17" Forward Cutting
1 X Dental Scaler 17" Reverse Cutting
1 X Periodontal Probe 17" 1.5mm Tip
1 X Dental Probe 17"
1 X Pouch

TV-28-1273
Farrier Tools kit
1 x Hoof Rasps
1 x Farrier Hammer
1 x Farrier Clincher
1 x Hoof Nipper
1 x Hoof Knife Blade
1 x Hoof Knife
1 x Hoof Pick
1 x Clinch Cutter



TV-28-1274
Farrier Tools kit
1 x Hoof Rasps
1 x Farrier Hammer
1 x Clinch Cutter
1 x Hoof Knife
1 x Hoof Nipper
1 x Shoe Puller
1 x Artificial Leather Pouch
for instruments



TV-28-1275
Hoof Knife Set



TV-28-1276
Farrier Tools kit
1 x Hoof Rasps
1 x Hoof Nipper
1 x Farrier Clincher
1 x Farrier Hammer
1 x Hoof Knife Blade
1 x Hoof Knife
1 x Clinch Cutter
1 x Leather Case for instruments.

DIAGNOSTIC INSTRUMENTS





WARM LIGHT VACUUM FROSTED LAMP



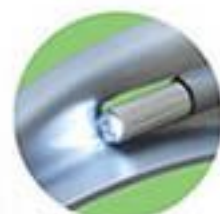
SPARE - VACUUM FROSTED LAMPS

Suitable for all conventional blades

	Size	for
TVS-29-2001	Small	Mac 0, Mil 00 - 1
TVS-29-2002	Large	Mac 1 - 5, Mil 2 - 4



LONG LIFE LED



Bright & White light for an efficient diagnosis

SPARE - LED lamps

Suitable for all conventional blades

	Size	for
TVS-29-2003	Small	Mac 0, Mil 00 - 1
TVS-29-2004	Large	Mac 1 - 5, Mil 2 - 4



Conventional Macintosh

Blades Fig.	Handle Size	Case Size	Conventional Vacuum frosted lamps	Conventional LED lamps
00,0,1	Small	Small	TVS-29-2005	TVS-29-2012
0,1,2	Small	Small	TVS-29-2006	TVS-29-2013
0,1,2,3	Medium	Large	TVS-29-2007	TVS-29-2014
1,2,3	Medium	Large	TVS-29-2008	TVS-29-2015
1,2,3,4	Medium	Large	TVS-29-2009	TVS-29-2016
0,1,2,3,4	Medium	Large	TVS-29-2010	TVS-29-2017
00,0,1,2,3,4	S + M	Large	TVS-29-2011	TVS-29-2018



Conventional Miller

Blades Fig.	Handle Size	Case Size	Conventional Vacuum frosted lamps	Conventional LED lamps
00,0,1	Small	Small	TVS-29-2019	TVS-29-2025
0,1,2	Small	Small	TVS-29-2020	TVS-29-2026
1,2,3	Medium	Large	TVS-29-2021	TVS-29-2027
1,2,3,4	Medium	Large	TVS-29-2022	TVS-29-2028
0,1,2,3,4	Medium	Large	TVS-29-2023	TVS-29-2029
00,0,1,2,3,4	S + M	Large	TVS-29-2024	TVS-29-2030



MACINTOSH, FLEXIBLE TIP

Integrated Fiber optic light guide

	Blades	Handle	Case
TVS-29-2031	1,2,3,4	Medium	Large
TVS-29-2032	2,3,4	Medium	Large
TVS-29-2033	3,4,5	Medium	Large
TVS-29-2034	3,4	Medium	Large
TVS-29-2035	4	Medium	Large
TVS-29-2036	5	Medium	Large

*Other set configurations are also available on demand



MACINTOSH, FLEXIBLE TIP

Integrated Fiber optic light guide

	Blades	Handle	Case
TVS-30-2037	3	Medium	Large
TVS-30-2038	4	Medium	Large
TVS-30-2039	3, 4	Medium	Large



Fiber Optic Macintosh

Blades	Handle	Case	Conventional	Conventional
Fig	Size	Size	Vacuum frosted lamps	LED lamps
00,0,1	Small	Small	TVS-30-2040	TVS-30-2046
00,0,1,2	Small	Small	TVS-30-2041	TVS-30-2047
1,2,3	Medium	Large	TVS-30-2042	TVS-30-2048
0,1,2,3	Medium	Large	TVS-30-2043	TVS-30-2049
1,2,3,4	Medium	Large	TVS-30-2044	TVS-30-2050
0,1,2,3,4	Medium	Large	TVS-30-2045	TVS-30-2051

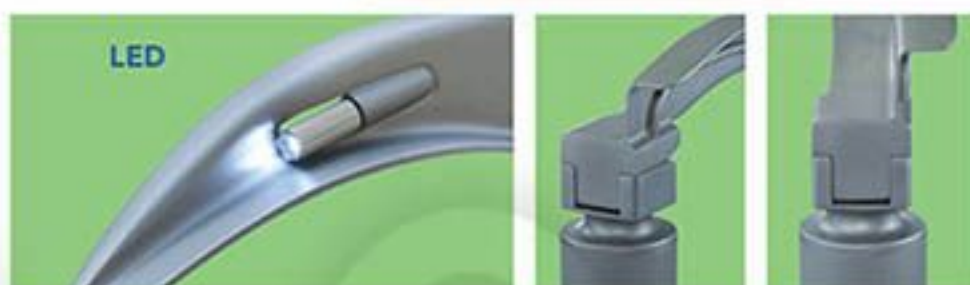


Fiber Optic Miller

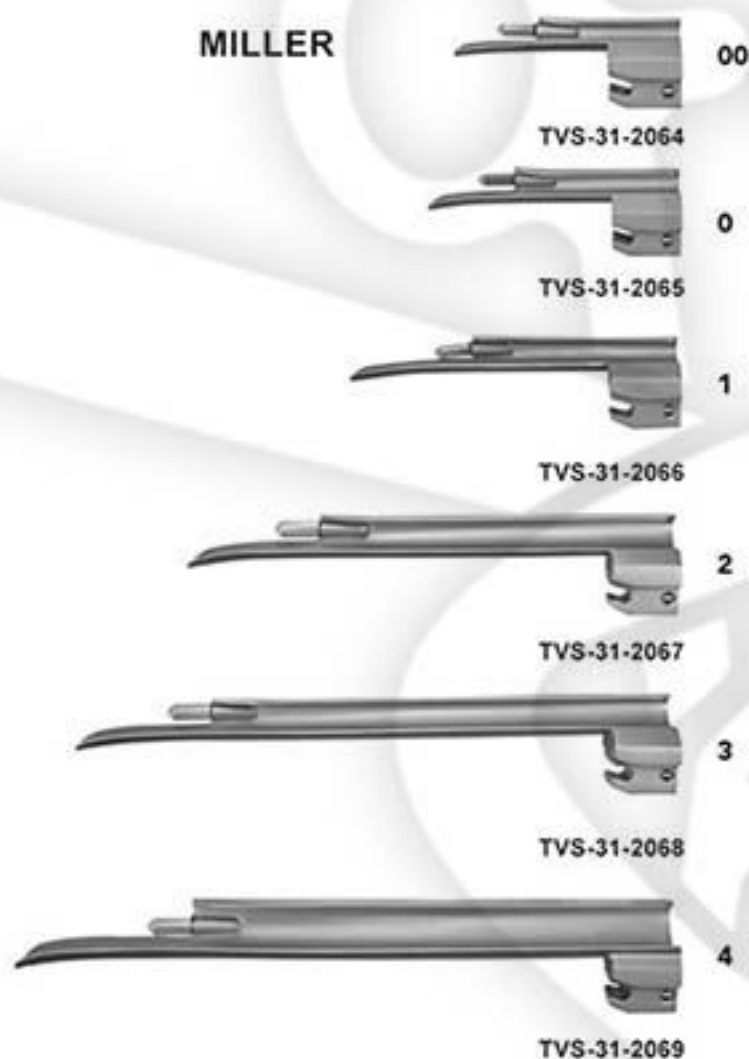
Blades	Handle	Case	Conventional	Conventional
Fig	Size	Size	Vacuum frosted lamps	LED lamps
00,0,1	Small	Small	TVS-30-2052	TVS-30-2058
00,0,1,2	Small	Small	TVS-30-2053	TVS-30-2059
1,2,3	Medium	Large	TVS-30-2054	TVS-30-2060
0,1,2,3	Medium	Large	TVS-30-2055	TVS-30-2061
1,2,3,4	Medium	Large	TVS-30-2056	TVS-30-2062
0,1,2,3,4	Medium	Large	TVS-30-2057	TVS-30-2063

*Other set configurations are also available on demand

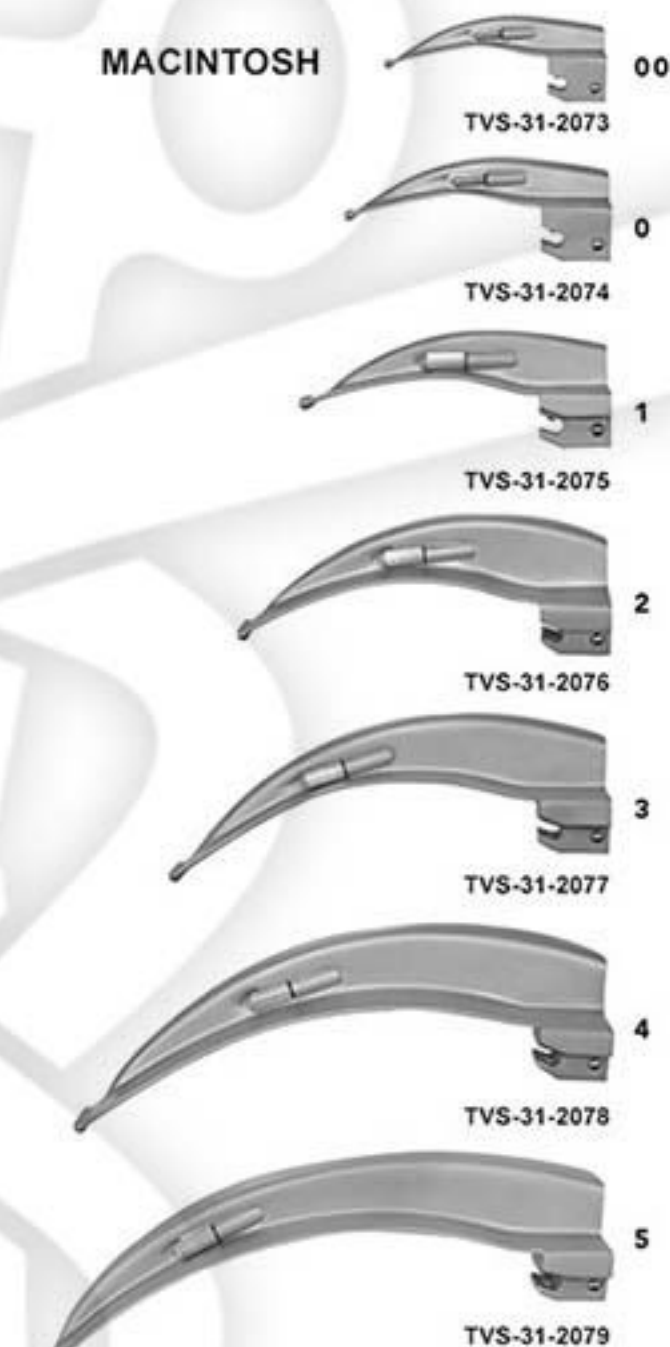
- Stainless steel construction
- Matte finish prevents back reflection
- With LED lamps
- White light, similar to natural day light
- Long life works thousands of hours without replacement
- Can be sterilized (refer to user manual)
- Compliant with ISO 7376 standards



MILLER



MACINTOSH



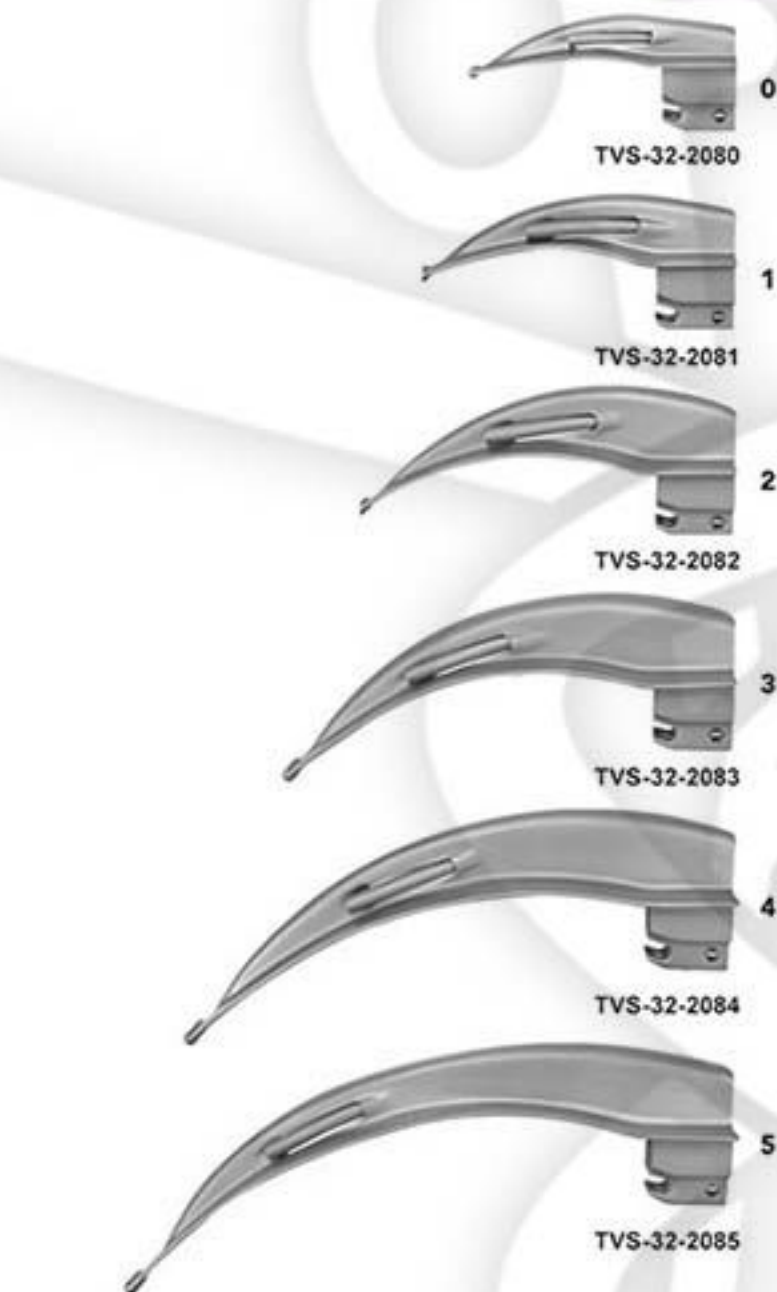
CONVENTIONAL HANDLES

Stainless Steel

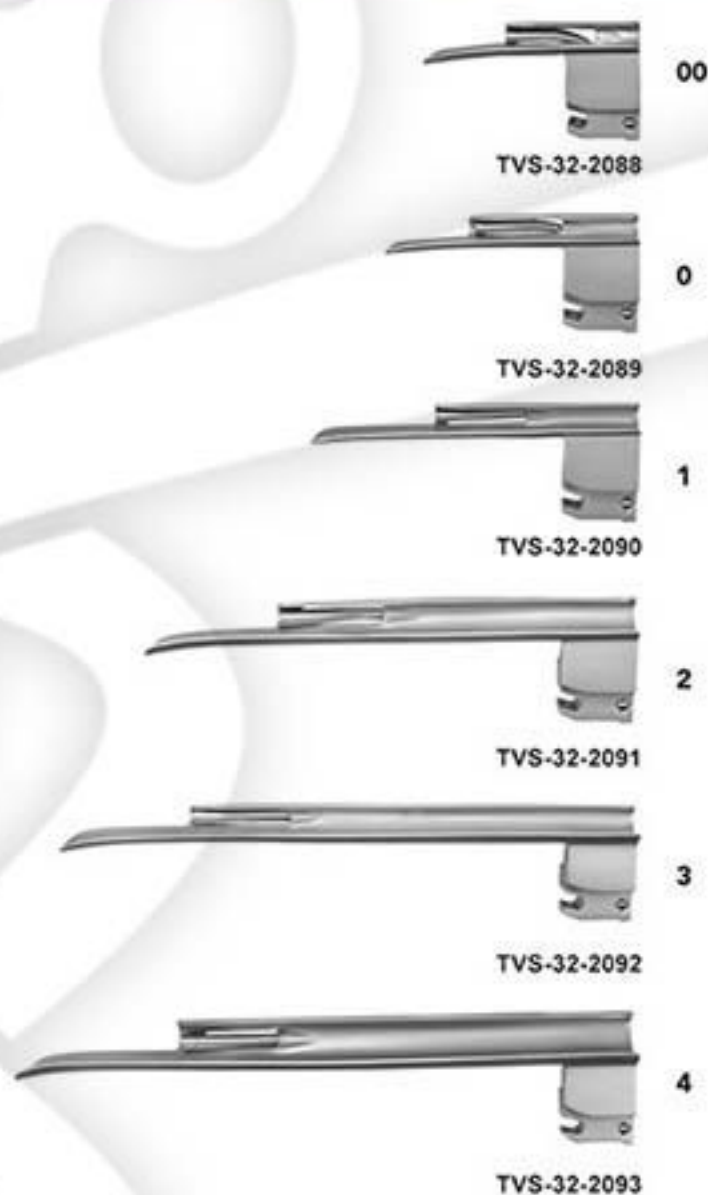


Fig.	A (mm)	B (mm)	C (mm)
00	05	8	41
0	82	9	60
1	96	14	73
2	115	15	93
3	136	16	115
4	166	16	138
5	179	17	157

- Stainless steel construction
- Matte finish prevents back reflection
- Replaceable light guide
- Easy to clean
- Cost-effective
- Fiber optic illumination \varnothing 4 mm (Fig. 2 - 4), \varnothing 3 mm (Fig. 00 - 1)
- Can be autoclaved at up to 134°C



GREEN SYSTEM HANDLES
With High powered LED, Stainless Steel



Medium & Stubby



Small

SPARE - CARTRIDGE
With High powered LED

	Size
TVS-32-2094	Small
TVS-32-2095	Medium & Stubby

Diagnostic Set

Full featured 2.5v set in artificial leather case with inner side blue eava & printed paper box

TVS-33-2096

Ophthalmoscope Head

- Is equipped with 29 corrective lenses from -35 to 40 diopter

Otoscope Head

- Has fitting for insufflator
- Comes with removable 3x magnifying lens
- 3 x Ear speculum /cannula with internal diameter Ø 2, 3 & 4 mm, reusable, made from polycarbonate, autoclave able at 121 °C
- 17 x Disposable Ear Speculum / Cannula For Pediatrics & Adults.

Battery Handle

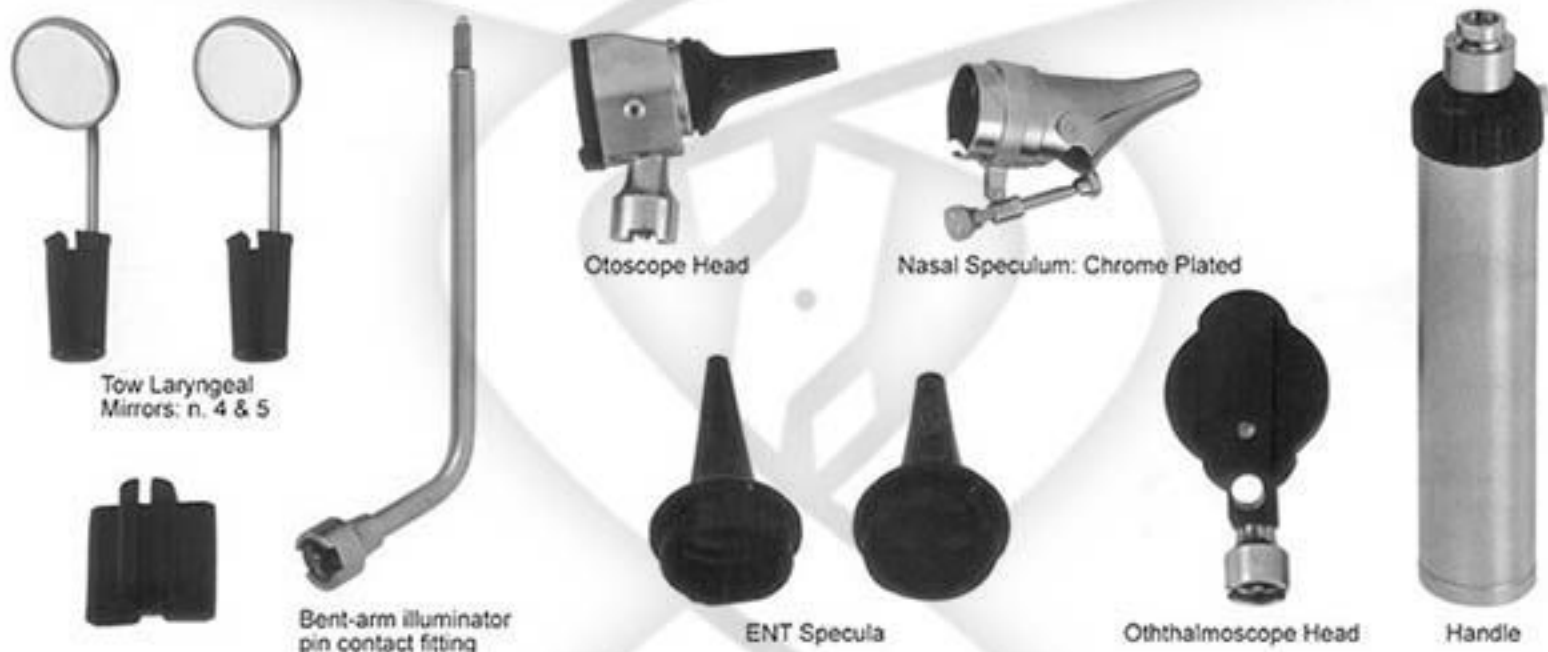
- Ensure connection to instrument heads with a bayonet locking System
- Require 2 "C" type batteries, not included
- Has knurled finish for better grip
- Has a rheostat to vary light intensity
- Spare lamp

Nasal Speculum

- Connects to the otoscope head and comes with manual screw for opening and closing of speculum

Bent Arm Illuminator

- Light the oral cavity and pharyngeal area
- Attaches to laryngeal mirrors No. 2 & 4 (included)
- Attaches to one metal tongue depressor (included)
- Attaches to one reusable adopter (included) that holds disposable tongue spatula



Otoscope

Full featured 2.5v set in artificial leather case with inner side blue eava & printed paper box

TVS-33-2097

Otoscope Head

- Has fitting for insufflator
- Comes with removable 3x magnifying lens
- Ear speculum/cannula with internal diameter Ø 2, 3 & 4 mm, reusable, made from polycarbonate, autoclave able at 121 °C

Battery Handle

- Ensures connection instrument heads with a bayonet locking system
- Requires 2 "C" type batteries, (not included)
- Has knurled finish for better grip
- Has a rheostat to vary light intensity
- Spare lamp



Ophthalmoscope

Full featured 2.5v set in artificial leather case with inner side blue eava & printed paper box

TVS-34-2098

Otoscope Head

- Has fitting for insufflator
- Comes with removable 3x magnifying lens
- Ear speculum/cannula with internal diameter Ø 2, 3 & 4 mm, Reusable, made from polycarbonate, autoclave able at 121 °C

Ophthalmoscope Head

- Is equipped with 2 corrective lenses from -35 to 40 diopter
- Battery Handle**
- Ensures connection to instrument heads with a bayonet
- Locking system
- Requires 2 "C" type batteries, not included
- Has knurled finish for better grip
- Has a rheostat to vary light intensity
- Spare lamp



Mini Ootoscope (Fiber Optic)

TVS-34-2099

2.5v Fiber Optic Helogen Light, Ootoscope head Pin Contact Fitting, Fixed Lens 6x on plastic mount may be removed for introduction of instruments, Reusable Ear Speculum/Canulas 2, 3 & 4 mm Battery handle made of plastic,

- "AA" battery handle (batteries not included) with power on/off button switch integrated into pocket clip
- Packed in Nylon pouch with belt loop & Color Printed Paper box



Veterinary Diagnostic Set

Full featured 2.5v set in artificial leather case with inner side blue eava & printed paper box

TVS-34-2100

Ophthalmoscope Head

- Is equipped with 29 corrective lenses from -35 to 40 diopter

Otoscope Head

- Has fitting for insufflators
- Comes with removable 3x magnifying lens
- 3 x Ear speculum /cannula with internal diameter Ø 4, 5 & 7 mm, Reusable, made from polycarbonate, autoclave able at 121 °C

Battery Handle

- Ensure connection to instrument heads with a bayonet locking System
- Require 2 "C" type batteries, not included
- Has knurled finish for better grip
- Has a rheostat to vary light intensity
- Spare lamp

Nasal Speculum

- Connects to the otoscope head and comes with manual screw for opening and closing of speculum

Bent Arm Illuminator

- Light the oral cavity and pharyngeal area
- Attaches to laryngeal mirrors No. 2 & 4 (included)
- Attaches to one metal tongue depressor (included)
- Attaches to one reusable adopter (included) that holds disposable tongue spatula



Veterinary Diagnostic Set

Full featured 2.5v set in artificial leather case with inner side blue eava & printed paper box

TVS-35-2101

Ophthalmoscope Head

Is equipped with 29 corrective lenses from -35 to 40 diopter

Otoscope Head

- Has fitting for insufflators
- Comes with removable 3x magnifying lens
- 3 x Ear speculum /cannula with internal diameter \varnothing 2,3 & 4 mm, And diameter \varnothing 4, 5 & 7 mm And 3 x For Pediatrics

Reusable, made from polycarbonate, autoclave able at 121 °C

Battery Handle

- Ensure connection to instrument heads with a bayonet locking System
- Require 2 "C" type batteries, not included
- Has knurled finish for better grip
- Has a rheostat to vary light intensity
- Spare lamp

Nasal Speculum

- Connects to the otoscope head and comes with manual screw for opening and closing of speculum

Bent Arm Illuminator

- Light the oral cavity and pharyngeal area
- Attaches to laryngeal mirrors No. 2 & 4 (included)
- Attaches to one metal tongue depressor (included)
- Attaches to one reusable adopter (included) that holds disposable tongue spatula



Veterinary otoscope Set

Full featured 2.5v set in artificial leather case with inner side blue eava & printed paper box

TVS-35-2102

Otoscope Head

- Has fitting for insufflators
- 6 x Reusable Plastic (polycarbonate) Ear speculum /cannula with internal diameter \varnothing 2 x 4mm, 2 x 5mm, 2 x 7 mm, And 3 x Reusable Metal (chrome plated) Ear Speculum / Canula with internal diameter \varnothing 1 x 4mm, 1 x 5mm, 1 x 7 mm,

Battery Handle

- Ensure connection to instrument heads with a bayonet locking System
- Require 2 "C" type batteries, not included
- Has knurled finish for better grip
- Has a rheostat to vary light intensity
- Spare lamp



Veterinary Otoscope Set

Full featured 2.5v set in artificial leather case with inner side blue eava & printed paper box

TVS-36-2103

Otoscope Head

- Has fitting for insufflators
- 9 x Reusable Plastic (polycarbonate) Ear speculum /cannula with internal diameter Ø 3 x 4mm, 3 x 5mm, 3x 7 mm,

Battery Handle

- Ensure connection to instrument heads with a bayonet locking System
- Require 2 "C" type batteries, not included
- Has knurled finish for better grip
- Has a rheostat to vary light intensity
- Spare lamp



Veterinary Diagnostic Set

Full featured 2.5v set in artificial leather case with inner side blue eava & printed paper box

TVS-36-2104

Otoscope Head with Open Construction

- Has fitting for insufflators
- 3 x Reusable Plastic (polycarbonate) Ear speculum /cannula with internal diameter Ø 1 x 4mm, 2 x 5mm, 1 x 7 mm,
- 5x magnifying lens

Battery Handle

- Ensure connection to instrument heads with a bayonet locking System
- Require 2 "C" type batteries, not included
- Has knurled finish for better grip
- Has a rheostat to vary light intensity
- Spare lamp

Nasal Speculum

- Connects to the otoscope head
- Hartman Alligator with 14 cm shaft



Veterinary Diagnostic Set

(Otoscope / ophthalmoscope)

Full featured 2.5v set in artificial leather case with inner side blue eava & printed paper box

TVS-37-2105

Ophthalmoscope Head

- Is equipped with 29 corrective lenses from -35 to 40 diopter

Otoscope Head

- Has fitting for insufflators
- Comes with removable 1x magnifying lens
- 3 x Ear speculum /cannula with internal diameter \varnothing 2,3 & 4 mm, Reusable, made from polycarbonate, autoclave able at 121 °C

Battery Handle

- Ensure connection to instrument heads with a bayonet locking System
- Require 2 "C" type batteries, not included
- Has knurled finish for better grip
- Has a rheostat to vary light intensity



Veterinary Diagnostic Set

(Otoscope / ophthalmoscope)

Full featured 2.5v set in artificial leather case with inner side blue eava & printed paper box

TVS-37-2106

Ophthalmoscope Head

- Is equipped with 29 corrective lenses from -35 to 40 diopter

Otoscope Head

- Has fitting for insufflators
- Comes with removable 1x magnifying lens
- 3 x Metal (chrome plated) Ear speculum /cannula with internal diameter \varnothing 2,3 & 4 mm Reusable, made from Metal chrome plated, autoclave able

Battery Handle

- Ensure connection to instrument heads with a bayonet locking System
- Require 2 "C" type batteries, not included
- Has knurled finish for better grip
- Has a rheostat to vary light intensity



TVS-38-2107

TYLOR Percussion Hammer
Latex-free
Waight 70g Length 20cm /8"



TVS-38-2108

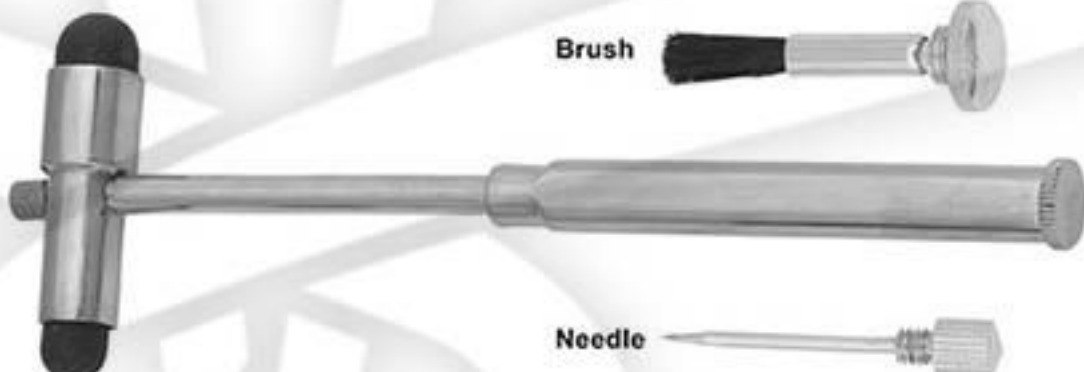
DEJERINE Percussion Hammer
Latex-free, with needle
Waight 115g Length 21cm /8 1/4"



Needle

TVS-38-2109

BUCK Percussion Hammer
Latex-free, with needle & brush
Waight 70g Length 20cm /8"



Brush

Needle

TVS-38-2110

BABINSKY Percussion Hammer
Latex-free, head Ø 45mm
Waight 130g Length 20cm /8"



Reversible Head



TVS-38-2111

TENDON / QUEEN Percussion Hammer
Latex-free, head Ø 50mm
Waight 113g Length 21cm /8 1/4"



TVS-38-2112

PINWHEEL
Medical-Wartenberg
Waight 70g Length 20cm /8"



TVS-39-2113
Diagnostic / Percussion
Hammer set



TVS-39-2114
Pinard (Wooden)



TVS-39-2115
Pinard (Wooden White)



TVS-39-2116
Pinard (Aluminium)

All instruments can be supplied
in following finishing.

- 1- Dull / Satin Finishing
- 2- Sand Finishing
- 3- Titanium Gold Color

- 4- TITANIUM BLUE COLOR
- 5- TITANIUM MULTI COLOR
- 6- BLACK COLOR

It's depends upon customer demand what they want.

TITANIUM MULTI COLOR



BLACK COLOR



TITANIUM GOLD



TITANIUM BLUE





TVS-40-2117
Sterile Scalpel
Blade Size # 10
Stainless Steel



TVS-40-2128
Sterile Scalpel
Blade Size # 11
Stainless Steel



TVS-40-2119
Sterile Scalpel
Blade Size # 12
Stainless Steel



TVS-40-2120
Sterile Scalpel
Blade Size # 13
Stainless Steel



TVS-40-2121
Sterile Scalpel
Blade Size # 15
Stainless Steel



TVS-40-2122
Sterile Scalpel
Blade Size # 15 A
Stainless Steel



TVS-40-2123
Sterile Scalpel
Blade Size # 21
Stainless Steel



TVS-40-2124
Sterile Scalpel
Blade Size # 22
Stainless Steel



TVS-40-2125
Sterile Scalpel
Blade Size # 23
Stainless Steel



TVS-40-2126
Sterile Scalpel
Blade Size # 24
Stainless Steel



TVS-40-2127
Sterile Scalpel
Blade Size # 25
Stainless Steel



TVS-41-2128-01
Scalpel Handle



1/8
TVS-41-2128
STANDARD
No.4
Solid



1/8
TVS-41-2129
Double Handle
No.4 + No.3
Solid



1/8
TVS-41-2130
No.4L
Straight
Solid



1/8
TVS-41-2131
No.4L
Solid Angled



1/8
TVS-41-2132
Collin
No.8
Hollow



1/8
TVS-41-2133
Collin
No.9
Hollow



TVS-42-2134-01
Scalpel Handle



TVS-42-2134
Standard
No.3
Solid
Size: 12cm



TVS-42-2135
No.3
Solid
Size: 12cm
Solid Handle
Style as
No.4



TVS-42-2136
No.3
Solid
Size: 12cm
cm-graduation



TVS-42-2137
No.3L
Straight
Solid, Long
Size: 21.5cm



TVS-42-2138
No.3L
Angled
Solid, Long
Size: 21cm



TVS-42-2139
No.7
Solid
Size: 16cm



TVS-42-2140
No.7K
Solid, Short
Size: 12.5cm

TVS-43-2141-01



TVS-43-2141-02



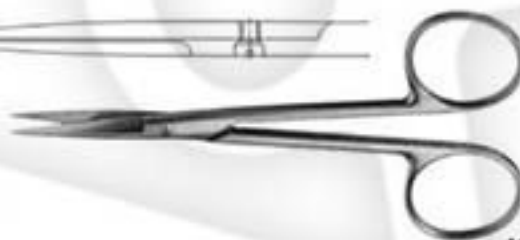
TVS-43-2141-01-02
METZENBAUM
Dissecting Scissors
Size: 145mm

1/2

TVS-43-2142-01



TVS-43-2142-02



TVS-43-2142-01-02
FINE SCISSORS
Size: 120mm

1/2

TVS-43-2143-01



TVS-43-2143-02



TVS-43-2143-01-02
IRIS
Size: 115mm

1/2

TVS-43-2144-01



TVS-43-2144-02



TVS-43-2144-01-02
JOSEPH
Size: 150mm

1/2

TVS-43-2145-01 cvd



TVS-43-2145-02 str



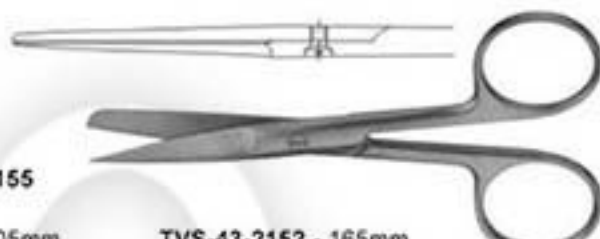
TVS-43-2145-01-02
KELLY
Size: 175mm

1/2

TVS-43-2146
Size: 110mm



1/2



TVS-43-2147 - 2155
Standard Types

TVS-43-2147 - 105mm
TVS-43-2148 - 115mm
TVS-43-2149 - 130mm
TVS-43-2150 - 145mm
TVS-43-2151 - 150mm

TVS-43-2152 - 165mm
TVS-43-2153 - 175mm
TVS-43-2154 - 185mm
TVS-43-2155 - 200mm

1/2



TVS-43-2156 - 2162
Standard Types

TVS-43-2156 - 115mm
TVS-43-2157 - 130mm
TVS-43-2158 - 145mm
TVS-43-2159 - 150mm

TVS-43-2160 - 165mm
TVS-43-2161 - 175mm
TVS-43-2162 - 185mm

1/2

TVS-43-2163 - 2167
Standard Types

TVS-43-2163 - 2167
Standard Types

TVS-43-2163 - 130mm
TVS-43-2164 - 145mm
TVS-43-2165 - 150mm

TVS-43-2166 - 165mm
TVS-43-2167 - 175mm

1/2

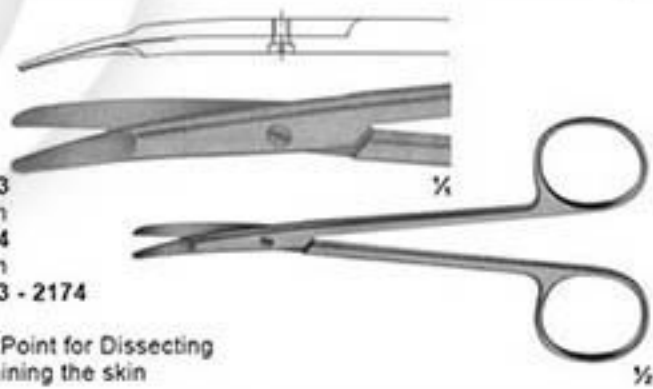
TVS-43-2168 - 2172
Standard Types - COOPER

TVS-43-2168 - 130mm
TVS-43-2169 - 145mm
TVS-43-2170 - 150mm

TVS-43-2171 - 165mm
TVS-43-2172 - 175mm

1/2

TVS-43-2173
Size: 125mm
TVS-43-2174
Size: 150mm
TVS-43-2173 - 2174
KILNER
Special Flat Point for Dissecting
And Undermining the skin



1/2

TVS-44-2175 - 2184
Standard Scissors

Straight

TVS-44-2175 - 115mm
TVS-44-2176 - 130mm
TVS-44-2177 - 145mm
TVS-44-2178 - 150mm
TVS-44-2179 - 165mm

Curved

TVS-44-2180 - 115mm
TVS-44-2181 - 130mm
TVS-44-2182 - 145mm
TVS-44-2183 - 160mm
TVS-44-2184 - 180mm

TVS-44-2185

TVS-44-2186

TVS-44-2185 - 2186

STEVENS
Vessel and tendon Scissors
Size: 110mm

TVS-44-2187

Fine dissecting Scissors
Size: 115mm

TVS-44-2188

DE BAKEY
Ateriotomy Scissors
Size: 175mm

TVS-44-2189

TVS-44-2190

TVS-44-2189 - 2190

TOENNIS - ADSON Dissecting Scissors
Size: 175mm

TVS-44-2191 - 2196

MAYO (Straight)
TVS-44-2191 - 140mm
TVS-44-2192 - 155mm
TVS-44-2193 - 170mm

MAYO (Curved)
TVS-44-2194 - 140mm
TVS-44-2195 - 155mm
TVS-44-2196 - 170mm

TVS-44-2197 - 2200

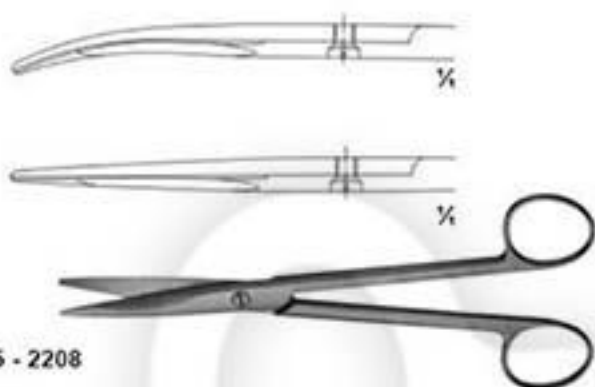
MAYO-STILLE (Straight)
TVS-44-2197 - 140mm
TVS-44-2198 - 170mm

MAYO-STILLE (Curved)
TVS-44-2199 - 140mm
TVS-44-2200 - 170mm

TVS-44-2201 - 2204

MAYO-STILLE (Straight)
With Chamfered Blades
TVS-44-2201 - 140mm
TVS-44-2202 - 170mm

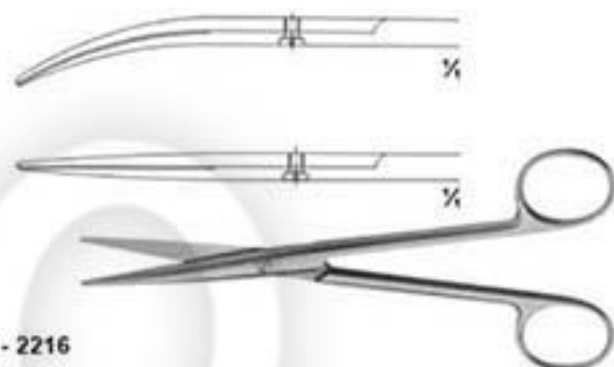
MAYO-STILLE (Curved)
TVS-44-2203 - 140mm
TVS-44-2204 - 170mm



TVS-45-2205 - 2208

MAYO (Straight)
With Chamfered Blades
TVS-45-2205 - 190mm
TVS-45-2206 - 215mm

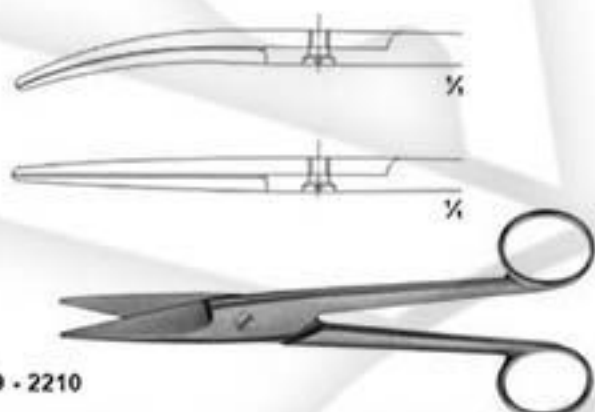
MAYO (Curved)
TVS-45-2207 - 190mm
TVS-45-2208 - 215mm



TVS-45-2215 - 2216

LEXER Narrow (Straight)
TVS-45-2215 - 165mm

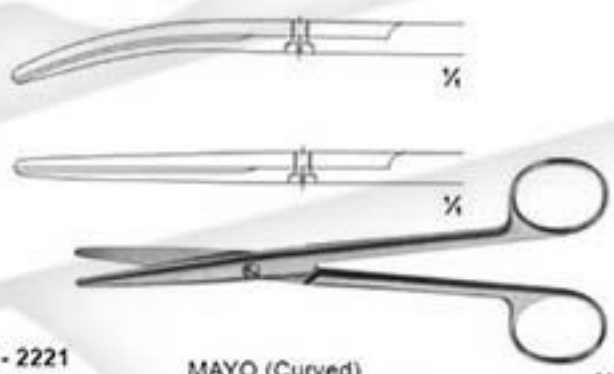
LEXER Narrow (Curved)
TVS-45-2216 - 165mm



TVS-45-2209 - 2210

MAYO-NOBLE (Straight)
(Broad pattern)
TVS-45-2209 - 170mm

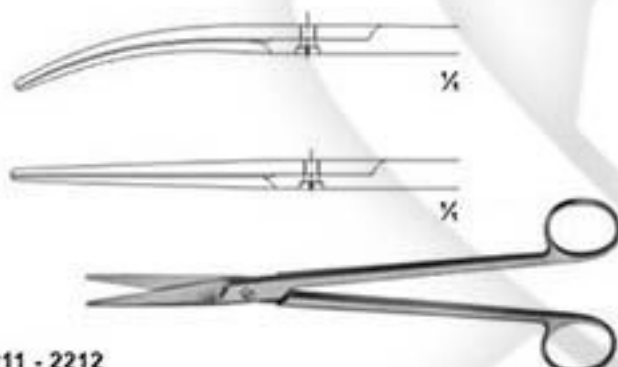
MAYO-NOBLE (Curved)
(Broad pattern)
TVS-45-2210 - 170mm



TVS-45-2217 - 2221

MAYO (Straight)
TVS-45-2217-01 - 165mm
TVS-45-2218-01 - 200mm

MAYO (Curved)
TVS-45-2219-01 - 165mm
TVS-45-2220-01 - 200mm
TVS-45-2221-01 - 210mm



TVS-45-2211 - 2212

MAYO-HARRINGTON (Straight)
TVS-45-2211 - 230mm

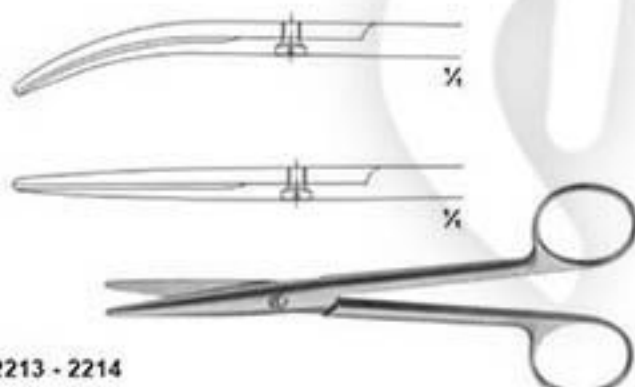
MAYO-HARRINGTON (Curved)
TVS-45-2212 - 230mm



TVS-45-2222 - 2223

BABY-METZENBAUM
(Straight)
TVS-45-2222 - 145mm

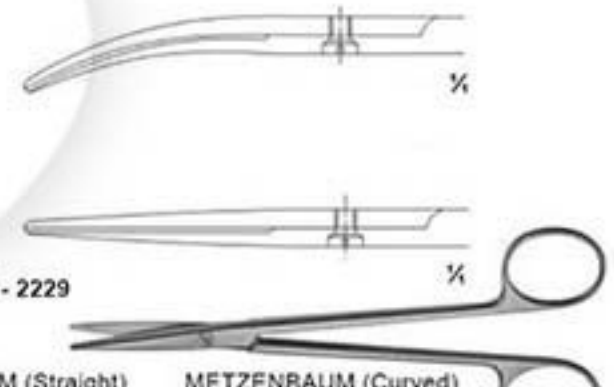
BABY-METZENBAUM
(Curved)
TVS-45-2223 - 145mm



TVS-45-2213 - 2214

STILLE (Straight)
TVS-45-2213 - 150mm

STILLE (Curved)
TVS-45-2214 - 150mm



TVS-45-2224 - 2229

METZENBAUM (Straight)
TVS-45-2224 - 145mm
TVS-45-2225 - 180mm
TVS-45-2226 - 200mm

METZENBAUM (Curved)
TVS-45-2227 - 145mm
TVS-45-2228 - 180mm
TVS-45-2229 - 200mm

(Curved)
TVS-46-2230 - 145mm
TVS-46-2231 - 180mm
TVS-46-2232 - 200mm

(Straight)
TVS-46-2233 - 145mm
TVS-46-2234 - 180mm
TVS-46-2235 - 200mm

METZENBAUM
TVS-46-2230 - 2235

TVS-46-2236 - 90mm
TVS-46-2237 - 115mm
TVS-46-2238 - 130mm
TVS-46-2239 - 140mm

STITCH REMOVAL SCISSOR
TVS-46-2236 - 2239

TVS-46-2240 - 230mm
TVS-46-2241 - 250mm
TVS-46-2242 - 280mm
TVS-46-2243 - 305mm

TVS-46-2244 - 230mm
TVS-46-2245 - 250mm
TVS-46-2246 - 280mm
TVS-46-2247 - 305mm

**NELSON
 METZENBAUM**
TVS-46-2240 - 2247

STITCH REMOVAL SCISSOR
TVS-46-2248
 Size: 140mm

TVS-46-2249
 Size: 120mm
 1 Blade Serrated

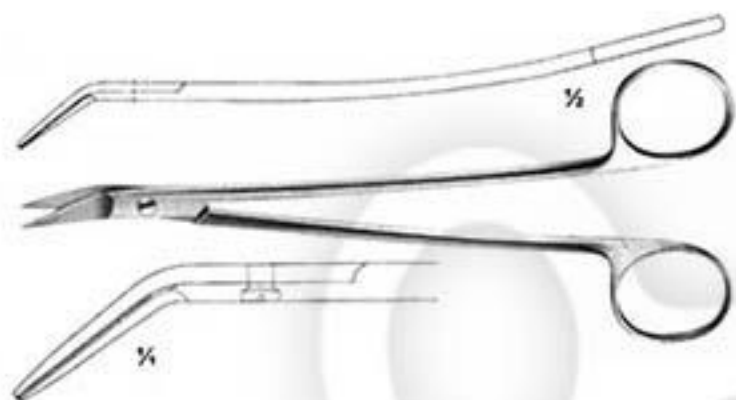
TVS-46-2250
 Size: 120mm
 Bowel Scissors

TVS-46-2251
POTTS-SMITH
 Size: 120mm

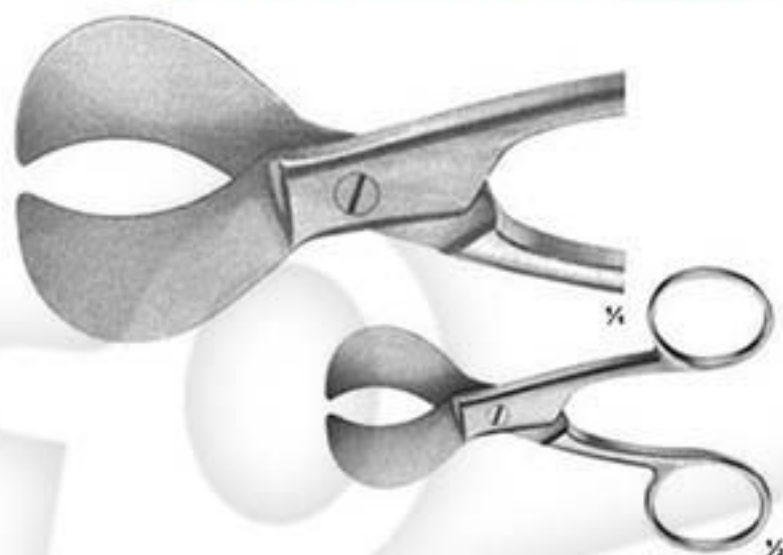
TVS-46-2252
 45

TVS-46-2253
 60

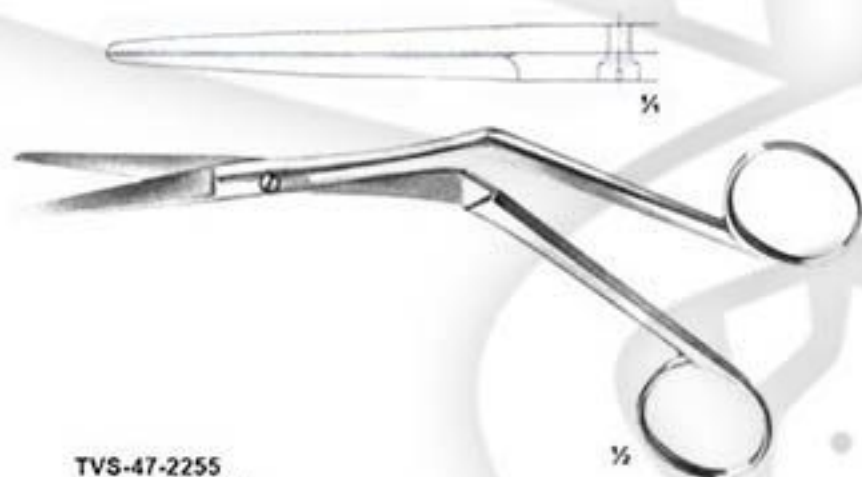
TVS-46-2252 - 2253
DE BAKEY
 Size: 155mm



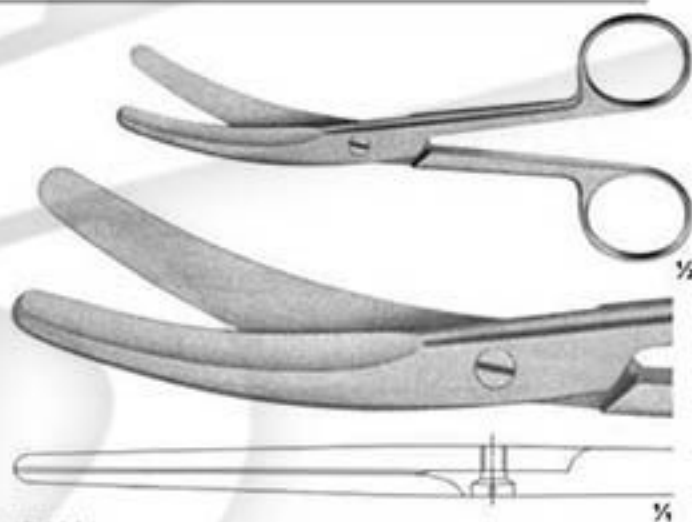
TVS-47-2254
DEAN Tonsil Scissors
Tip: B/B Blade: ANG-SERR
Size: 17cm



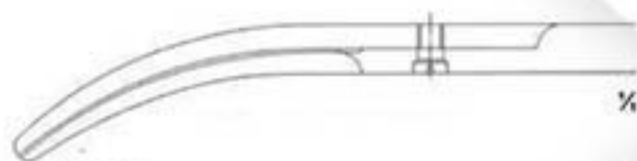
TVS-47-2260
Umbilical Cord Scissors
Size: 105mm



TVS-47-2255
Heymann-knight
Nasal Scissors
Size: 19cm



TVS-47-2261
Umbilical Cord Scissors
Size: 135mm



Curved
TVS-47-2256 - 200mm
TVS-47-2257 - 230mm

TVS-47-2262 - 145mm



Straight
TVS-47-2258 - 200mm
TVS-47-2259 - 230mm

TVS-47-2263 - 180mm

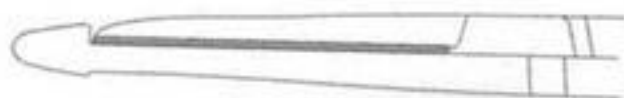


TVS-47-2256 - 2259
SIMS

TVS-47-2264 - 200mm



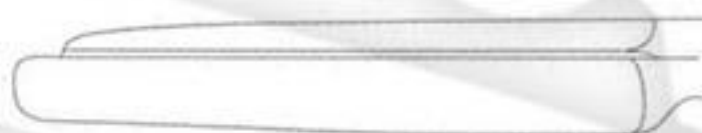
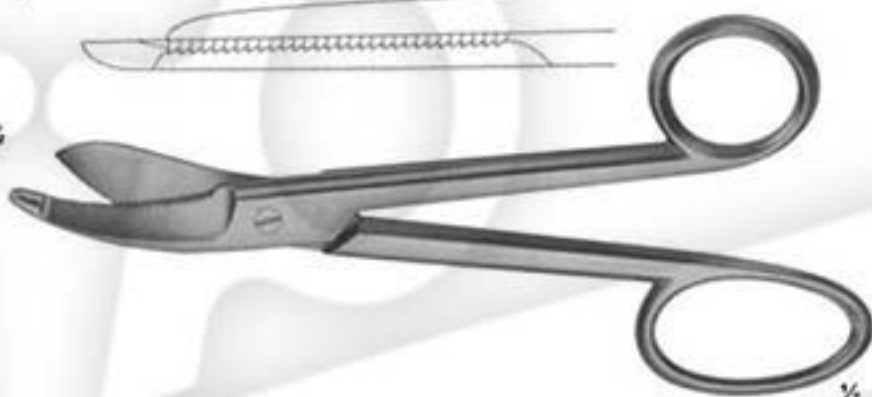
TVS-47-2262 - 2264
BRAUN-STADLER
Episiotomy Scissors



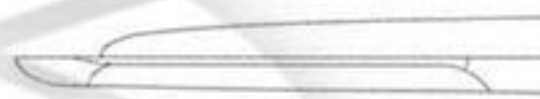
TVS-48-2265
CLOTH SCISSORS
205mm



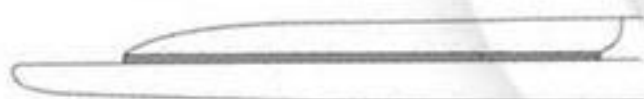
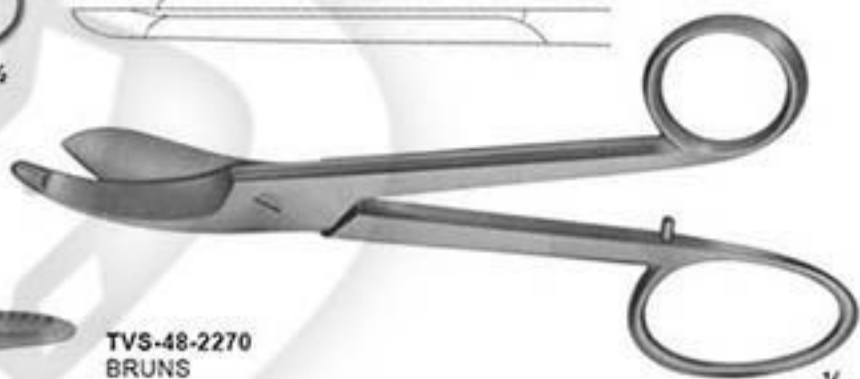
TVS-48-2269
BANDAGE SCISSORS
180mm



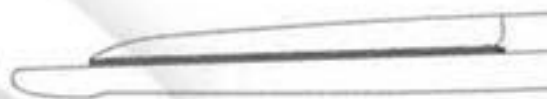
TVS-48-2266
BRAUN-STADLER
Bandage Scissors
225mm



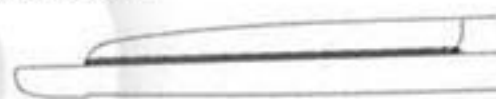
TVS-48-2270
BRUNS
Plaster Scissors
235mm



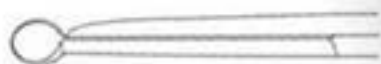
TVS-48-2267
SEUTIN
Plaster Scissors
230mm



TVS-48-2271 - 230mm



TVS-48-2272 - 230mm

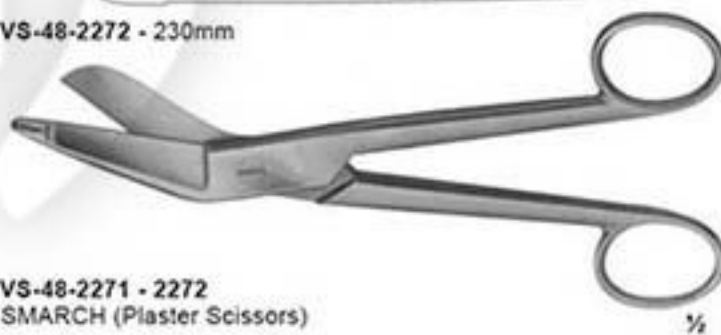


TVS-48-2268-01-04
LISTER

TVS-48-2268-01	115mm
TVS-48-2268-02	145mm
TVS-48-2268-03	160mm
TVS-48-2268-04	180mm



TVS-48-2271 - 2272
ESMARCH (Plaster Scissors)



TVS-49-2273-01-02
UNIVERSAL
PARAMEDIC SCISSORS
(BLACK)

TVS-49-2273-01 **TVS-49-2273-02**
145mm 185mm



TVS-49-2277-01-02
UNIVERSAL
PARAMEDIC SCISSORS
(BLUE)

TVS-49-2277-01 **TVS-49-2277-02**
145mm 185mm



TVS-49-2274-01-02
UNIVERSAL
PARAMEDIC SCISSORS
(ORANGE)

TVS-49-2274-01 **TVS-49-2274-02**
145mm 185mm



TVS-49-2278-01-02
UNIVERSAL
PARAMEDIC SCISSORS
(YELLOW)

TVS-49-2278-01 **TVS-49-2278-02**
145mm 185mm



TVS-49-2275-01-02
UNIVERSAL
PARAMEDIC SCISSORS
(WHITE)

TVS-49-2275-01 **TVS-49-2275-02**
145mm 185mm



TVS-49-2279-01-02
UNIVERSAL
PARAMEDIC SCISSORS
(BURGUNDY)

TVS-49-2279-01 **TVS-49-2279-02**
145mm 185mm



TVS-49-2276-01-02
UNIVERSAL
PARAMEDIC SCISSORS
(BLACK)

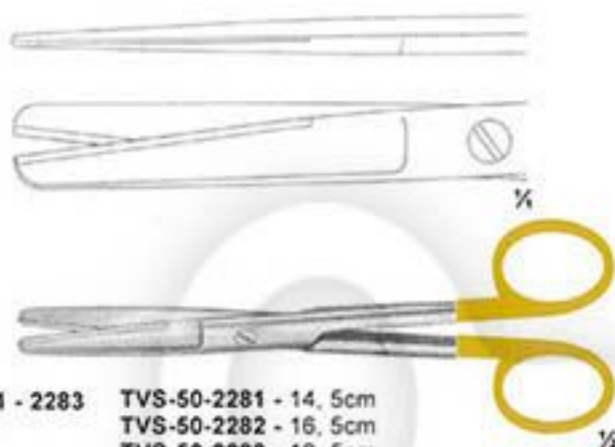
TVS-49-2276-01 **TVS-49-2276-02**
145mm 185mm



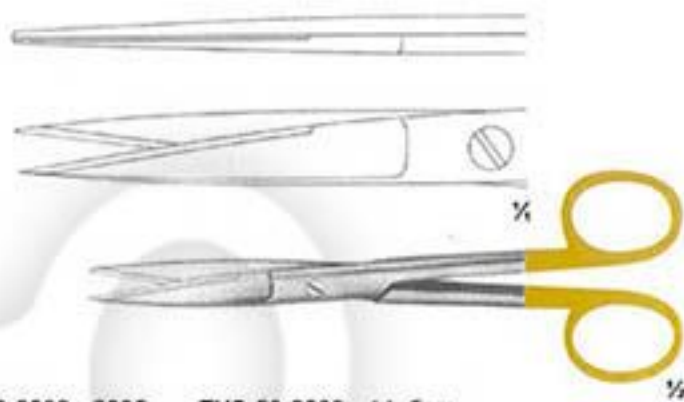
TVS-49-2280-01-02
UNIVERSAL
PARAMEDIC SCISSORS
(DEEP YELLOW)

TVS-49-2280-01 **TVS-49-2280-02**
145mm 185mm

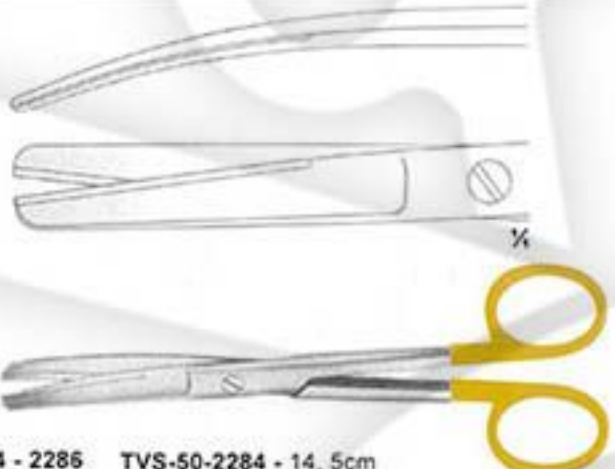




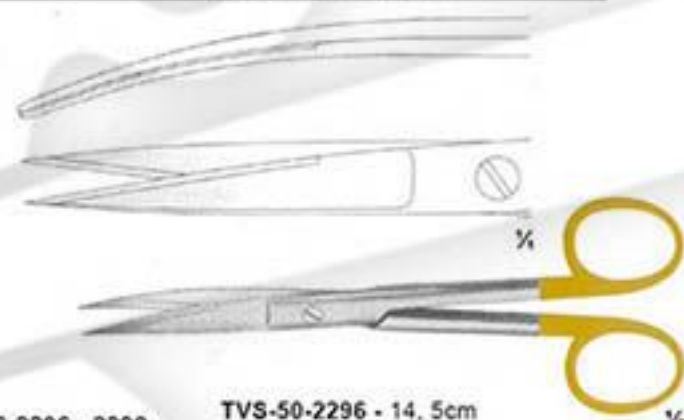
TVS-50-2281 - 2283
STANDARD
TVS-50-2281 - 14, 5cm
TVS-50-2282 - 16, 5cm
TVS-50-2283 - 18, 5cm



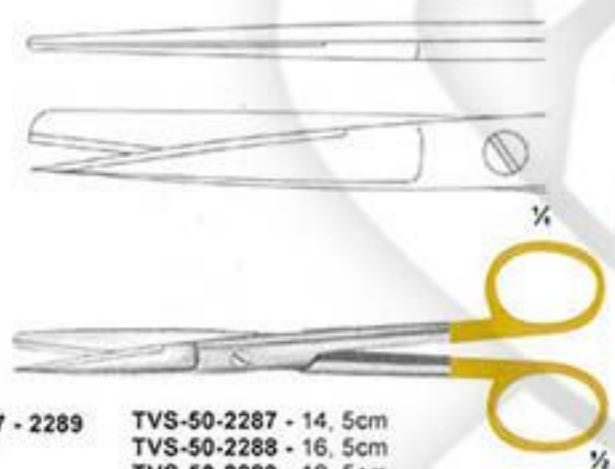
TVS-50-2293 - 2295
STANDARD
TVS-50-2293 - 14, 5cm
TVS-50-2294 - 16, 5cm
TVS-50-2295 - 18, 5cm



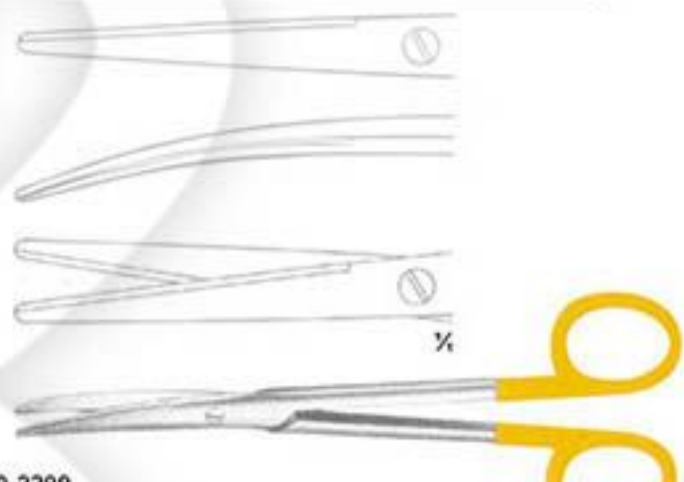
TVS-50-2284 - 2286
STANDARD
TVS-50-2284 - 14, 5cm
TVS-50-2285 - 16, 5cm
TVS-50-2286 - 18, 5cm



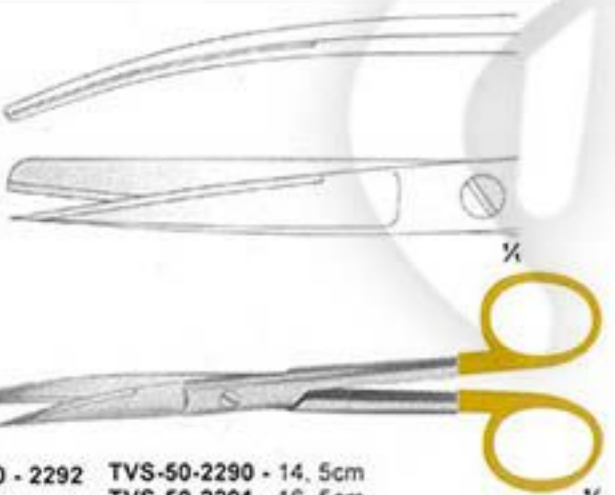
TVS-50-2296 - 2298
STANDARD
TVS-50-2296 - 14, 5cm
TVS-50-2297 - 16, 5cm
TVS-50-2298 - 18, 5cm



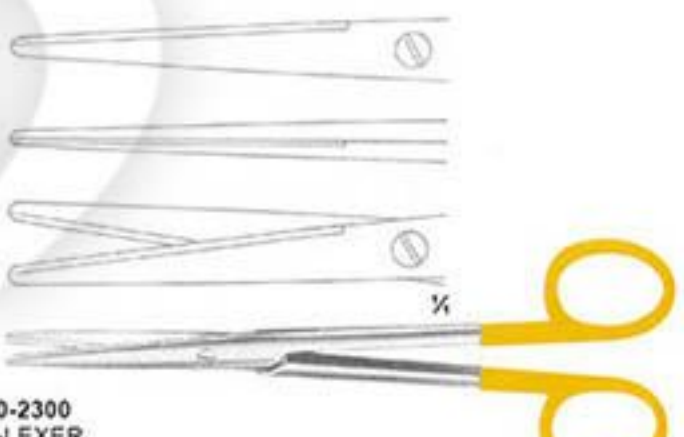
TVS-50-2287 - 2289
STANDARD
TVS-50-2287 - 14, 5cm
TVS-50-2288 - 16, 5cm
TVS-50-2289 - 18, 5cm



TVS-50-2299
MAYO-LEXER
16cm



TVS-50-2290 - 2292
STANDARD
TVS-50-2290 - 14, 5cm
TVS-50-2291 - 16, 5cm
TVS-50-2292 - 18, 5cm



TVS-50-2300
MAYO-LEXER
16cm



TVS-51-2301 - 2302
LEXER

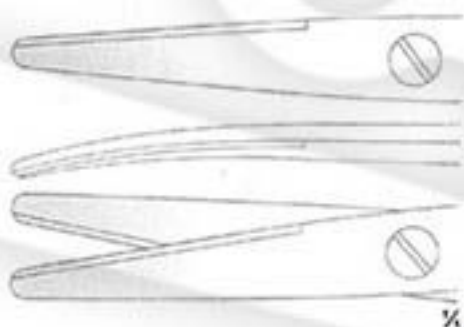
TVS-51-2301 - 16cm
TVS-51-2302 - 21cm



TVS-51-2309 - 2315
LEXER

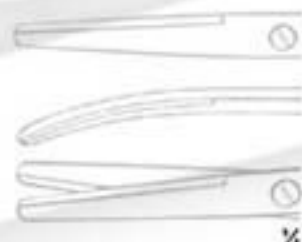
TVS-51-2309 - 14cm
TVS-51-2310 - 18cm
TVS-51-2311 - 20cm
TVS-51-2312 - 23.5cm

TVS-51-2313 - 25.5cm
TVS-51-2314 - 28cm
TVS-51-2315 - 30cm



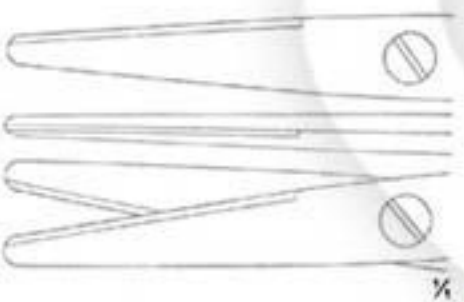
TVS-51-2303 - 2304
MAYO-STILLE

TVS-51-2303 - 15cm
TVS-51-2304 - 17cm



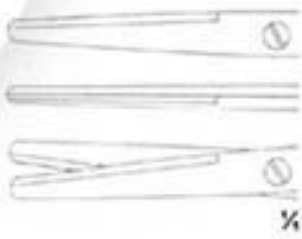
TVS-51-2316 - 2317
METZENBAUM

TVS-51-2316 - 11.5cm
TVS-51-2317 - 14.5cm



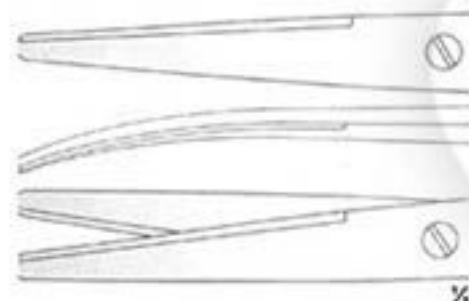
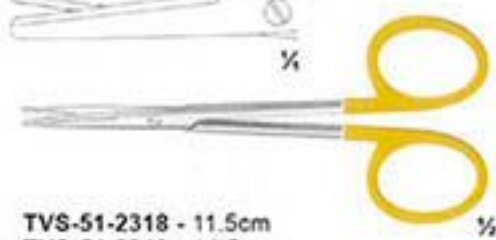
TVS-51-2305 - 2306
MAYO-STILLE

TVS-51-2305 - 15cm
TVS-51-2306 - 17cm



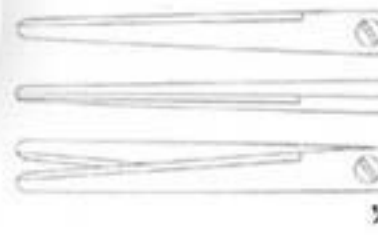
TVS-51-2318 - 2319
METZENBAUM

TVS-51-2318 - 11.5cm
TVS-51-2319 - 14.5cm



TVS-51-2307 - 2308
LEXER

TVS-51-2307 - 16cm
TVS-51-2308 - 21cm

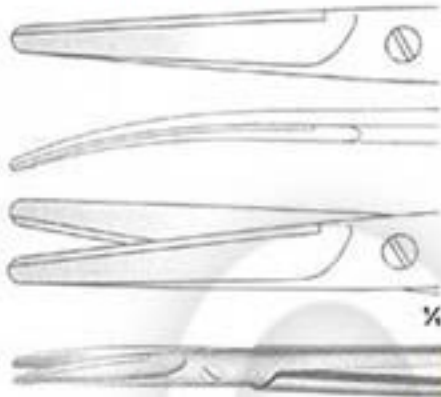


TVS-51-2320 - 2325
METZENBAUM - FINO

TVS-51-2320 - 14cm
TVS-51-2321 - 18cm
TVS-51-2322 - 20cm

TVS-51-2323 - 23cm
TVS-51-2324 - 25cm
TVS-51-2325 - 28cm





TVS-52-2326 - 2328
MAYO

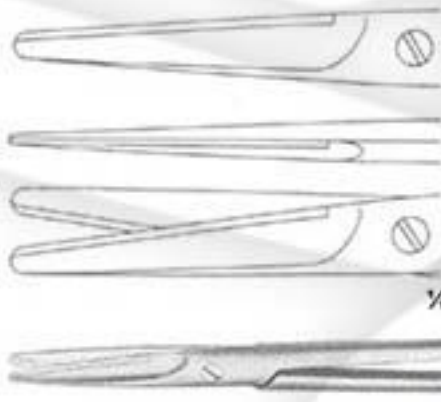
TVS-52-2326 - 14.5cm
TVS-52-2327 - 17cm
TVS-52-2328 - 23cm



TVS-52-2334 - 23cm 25°
TVS-52-2335 - 23cm 45°
TVS-52-2336 - 23cm 60°



TVS-52-2337
19cm 25°
TVS-52-2338
19cm 45°
TVS-52-2339
19cm 60°



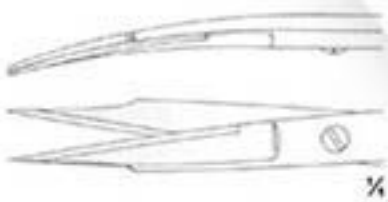
TVS-52-2329 - 2331
MAYO

TVS-52-2329 - 14.5cm
TVS-52-2330 - 17cm
TVS-52-2331 - 23cm

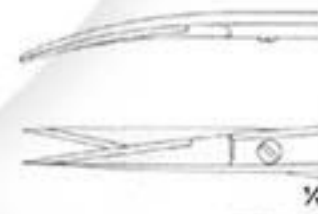


TVS-52-2334 - 2336
DE-BAKEY
(Potts-Smith)

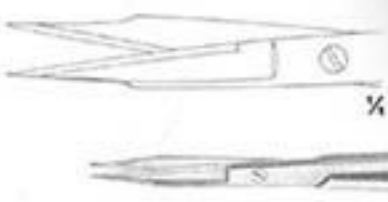
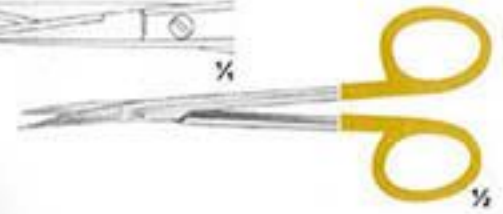
TVS-52-2337 - 2339
DE-BAKEY
(Potts-Smith)



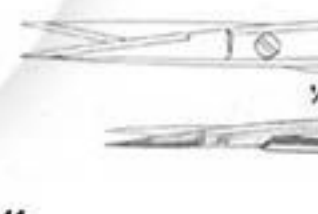
TVS-52-2332
GOLDMANN FOX



TVS-52-2340
Fine Scissors
11.5cm

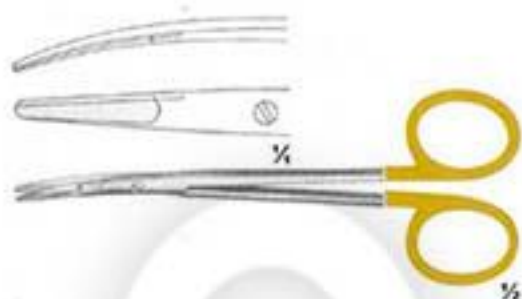


TVS-52-2333
GOLDMANN FOX

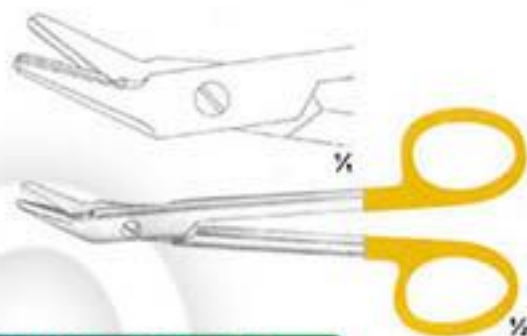


TVS-52-2341
Fine Scissors
11.5cm





TVS-53-2342
11,5cm



TVS-53-2347-01
UNIVERSAL
12cm



TVS-53-2343
RAGNELL (Kilner)
12cm

SUPER CUT SCISSORS



TVS-53-2348-01-02
TVS-53-2348-01
Laxer Operating
Super Cut Scissors
160mm
TVS-53-2348-02
Laxer Operating
Super Cut Scissors
210mm



TVS-53-2344-01-02
TVS-53-2344-01
Stevens Tenotomy
Super Cut Scissors
Straight 115mm
TVS-53-2344-02
Stevens Tenotomy
Super Cut Scissors
Curved 115mm



TVS-53-2345-01-02
TVS-53-2345-01
IRIS
Super Cut Scissors
Straight 115mm
TVS-53-2345-02
IRIS
Super Cut Scissors
Curved 115mm



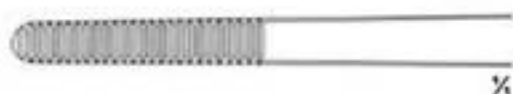
TVS-53-2346-01-02
TVS-53-2346-01
METZENBAUM
Super Cut Scissors
Straight 115mm
Straight 145mm
Straight 160mm
Straight 180mm
TVS-53-2346-02
METZENBAUM
Super Cut Scissors
Curved 115mm
Curved 145mm
Curved 160mm
Curved 180mm



TVS-53-2349 - 2351
Standard Operating Super Cut Scissors



TVS-53-2352 - 2354
Standard Operating Super Cut Scissors



TVS-54-2355 - 2362
STANDARD

TVS-54-2355 - 115mm
TVS-54-2356 - 130mm
TVS-54-2357 - 145mm
TVS-54-2358 - 160mm

TVS-54-2359 - 180mm
TVS-54-2360 - 200mm
TVS-54-2361 - 250mm
TVS-54-2362 - 300mm

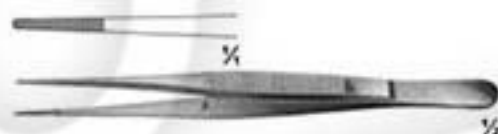


TVS-54-2377
BONNEY
175mm



TVS-54-2363 - 2367
MEDIUM

TVS-54-2363 - 115mm
TVS-54-2364 - 130mm
TVS-54-2365 - 145mm
TVS-54-2366 - 160mm
TVS-54-2367 - 305mm



TVS-54-2378 - 2379
SEMKEN

TVS-54-2378 - 125mm
TVS-54-2379 - 150mm

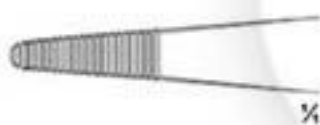


TVS-54-2368 - 2369
MEDIUM

TVS-54-2368 - 115mm
TVS-54-2369 - 130mm



TVS-54-2380
MICRO-ADSON
150mm

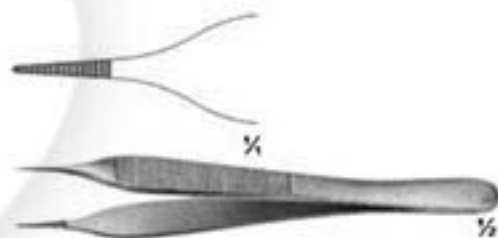


TVS-54-2370 - 2371

TVS-54-2370 - 125mm
TVS-54-2371 - 115mm



TVS-54-2381
MICRO-ADSON
120mm

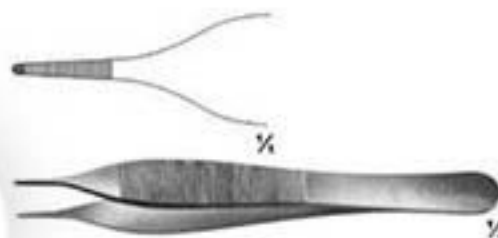


TVS-54-2372 - 2375
Swedish pattern

TVS-54-2372 - 130mm
TVS-54-2373 - 150mm
TVS-54-2374 - 170mm
TVS-54-2375 - 200mm



TVS-54-2382
ADSON
120mm



TVS-54-2376
OCHSNER
Ligature Forceps
145mm

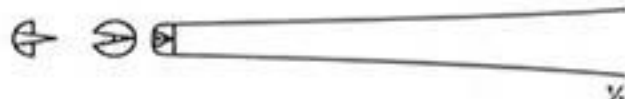


TVS-54-2383
MC INDOE
150mm





TVS-55-2384
GILLIES
155mm



TVS-55-2389-01-09
TISSUE

TVS-55-2389-01 105mm	TVS-55-2389-06 180mm
TVS-55-2389-02 115mm	TVS-55-2389-07 200mm
TVS-55-2389-03 130mm	TVS-55-2389-08 250mm
TVS-55-2389-04 145mm	TVS-55-2389-09 300mm
TVS-55-2389-05 160mm	



TVS-55-2385
ADSON-BROWN
Non-traumatic
120mm



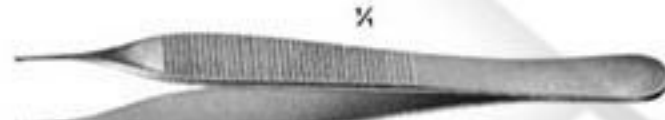
TVS-55-2390 - 140mm
LUCAE
1x2 Teeth



TVS-55-2386
ADSON
120mm



TVS-55-2391 - 200mm
RUSS.MODLE



TVS-55-2387
MICRO ADSON
120mm



TVS-55-2392 - 175mm
BONNEY



TVS-55-2388-01-02
TVS-55-2388-01 ADSON TOOTH 120mm
TVS-55-2388-02 ADSON TOOTH 150mm



TVS-55-2393 - 2394 DE BAKEY
TVS-55-2393 - 150mm
TVS-55-2394 - 200mm



TVS-55-2395 - 2398 DE BAKEY
TVS-55-2395 - 150mm
TVS-55-2396 - 200mm
TVS-55-2397 - 240mm
TVS-55-2398 - 300mm



TVS-56-2399 - 2402
DE BAKAY

TVS-56-2399 - 150mm
TVS-56-2400 - 200mm
TVS-56-2401 - 240mm
TVS-56-2402 - 300mm



TVS-56-2403 - 200mm
DE BAKAY

DIEFFENBACH

TVS-56-2404
38mm
48mm



DIEFFENBACH

TVS-56-2405
38mm
48mm



GLOVER
TVS-56-2406-01
TVS-56-2406-02
TVS-56-2406-03

TOTAL LENGTH	LENGTH OF JAW
65mm	33mm
91mm	50mm
110mm	69mm



GLOVER
TVS-56-2407-01
TVS-56-2407-02
TVS-56-2407-03

TOTAL LENGTH	LENGTH OF JAW
68mm	33mm
96mm	50mm
117mm	69mm



TVS-56-2408-01-02
TVS-56-2408-01
ADSON TOOTH
120mm

TVS-56-2408-02
ADSON TOOTH
150mm

TVS-56-2409-01
12cm

TVS-56-2409-02
15cm



TVS-56-2409-01-02
ADSON



TVS-56-2410
GRUENWALD JANSEN Nasal
Dressing Forceps
20cm/8"



TVS-56-2411-01-02
TROELTSCH Hasal
Dressing Forceps

TVS-56-2411-01 - 15cm/6"
TVS-56-2411-02 - 18cm/7"



TVS-56-2412
CUSHING
With Dissector
end 17.5cm



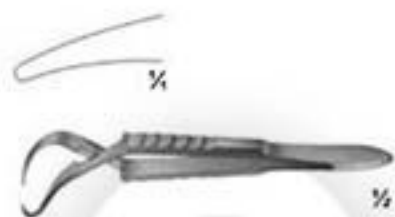
TVS-56-2413
SEMKEN
15cm



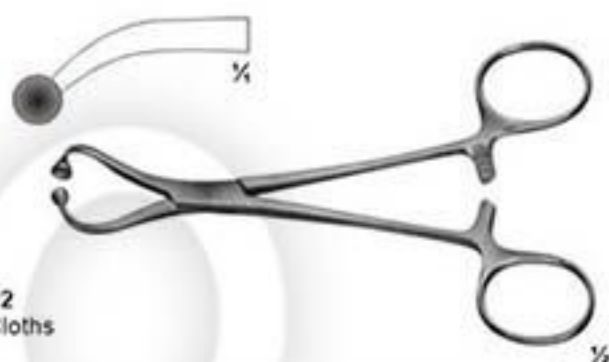
TVS-56-2414
CASTROVIEJO
14cm



TVS-56-2415
CASTROVIEJO
14cm



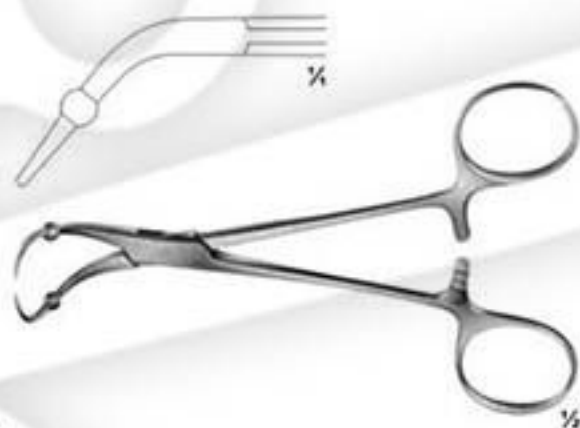
TVS-57-2416
JONES
85mm



TVS-57-2422
For Paper Cloths
140mm



TVS-57-2417
ENGL. MOD.
85mm



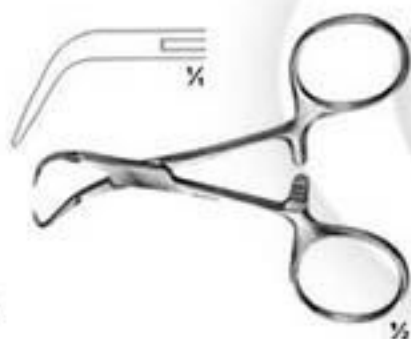
TVS-57-2423
ROEDER
160mm



TVS-57-2418
DOYEN
180mm

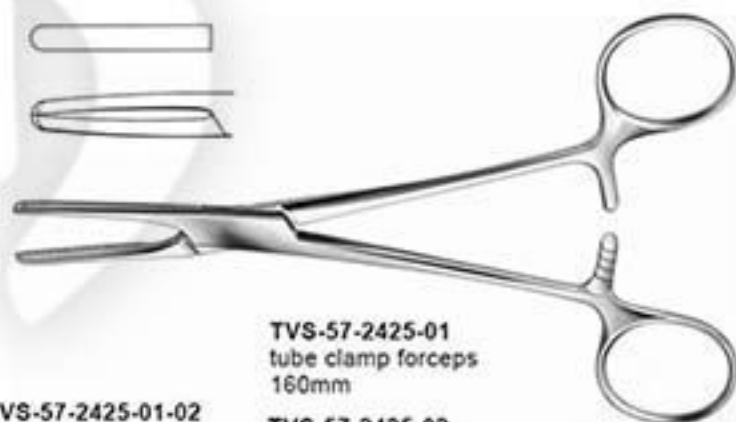


TVS-57-2424
LORNA
non perforating
130mm



TVS-57-2419 - 2421
BACKHAUS

TVS-57-2419 - 90mm
TVS-57-2420 - 110mm
TVS-57-2421 - 135mm

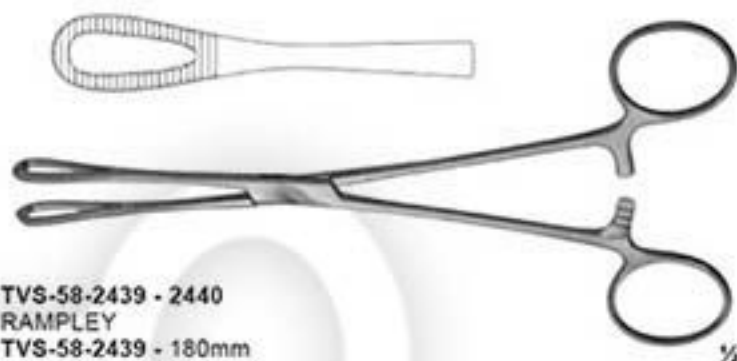


TVS-57-2425-01-02

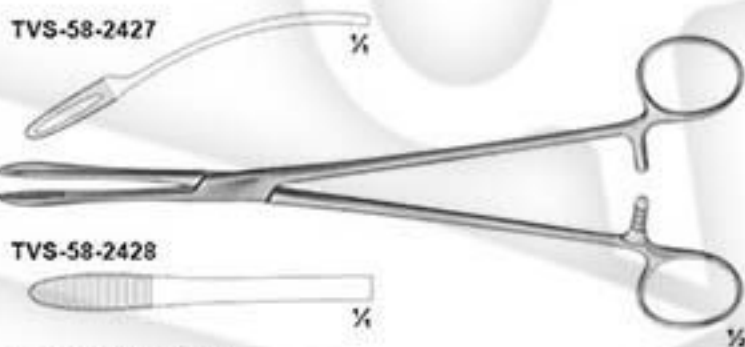
TVS-57-2425-01
tube clamp forceps
160mm
TVS-57-2425-02
tube clamp forceps
180mm



TVS-58-2426
CHERON
Handle Laterally Angled
240mm



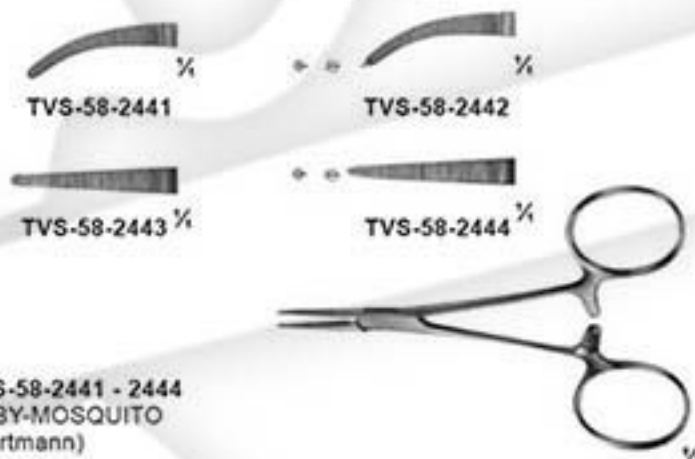
TVS-58-2439 - 2440
RAMPLEY
TVS-58-2439 - 180mm
TVS-58-2440 - 250mm



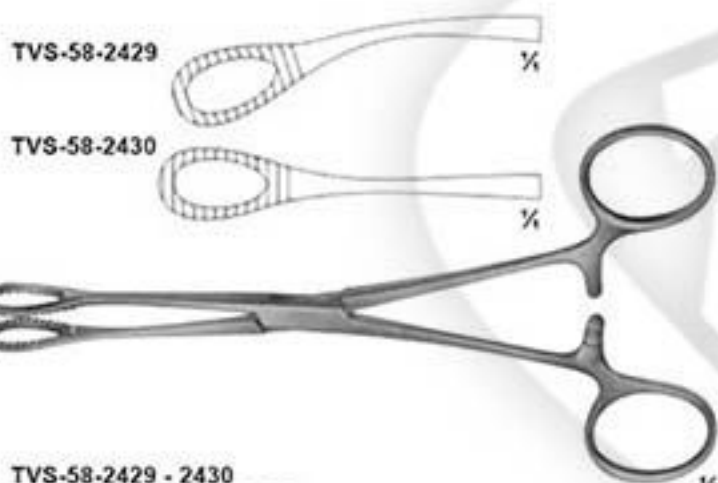
TVS-58-2427

TVS-58-2428

TVS-58-2427 - 2428
COLLIN
240mm



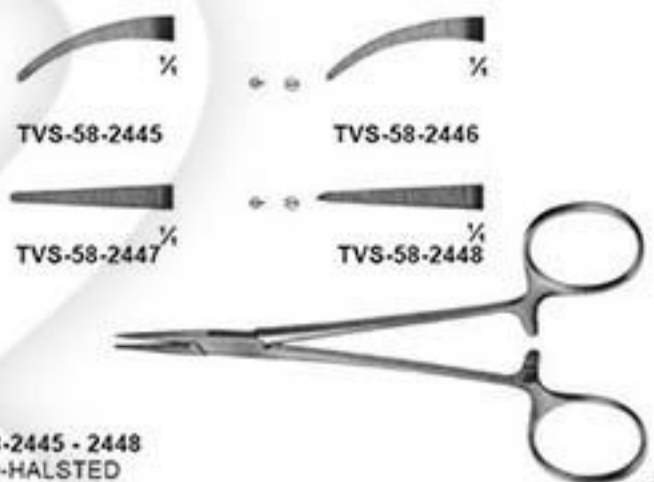
TVS-58-2441 - 2444
BABY-MOSQUITO
(Hartmann)
100mm



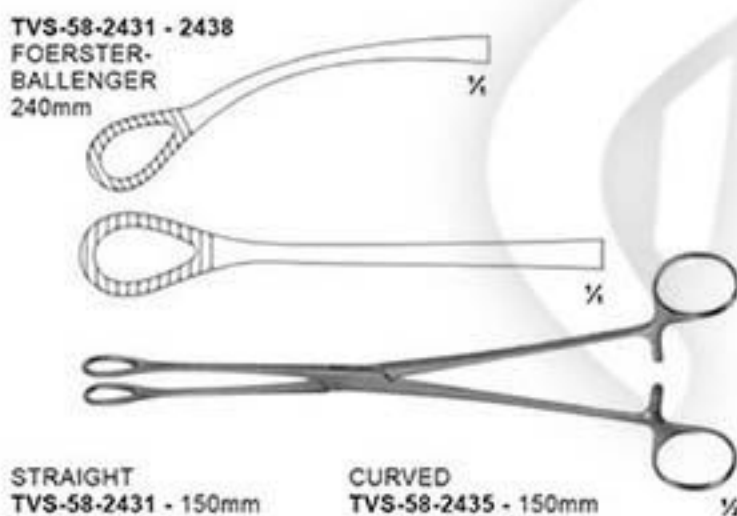
TVS-58-2429

TVS-58-2430

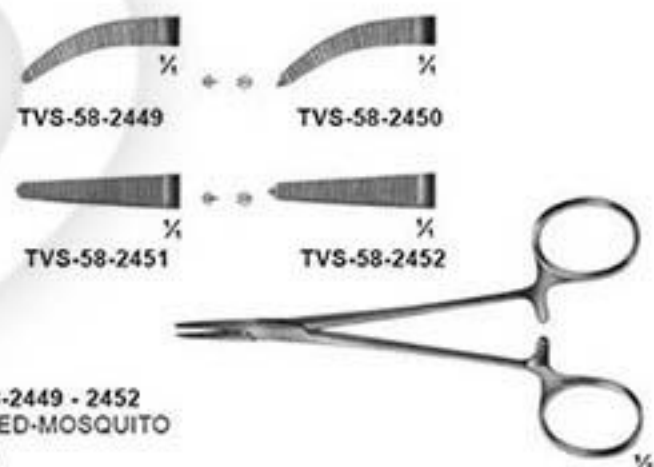
TVS-58-2429 - 2430
FOERSTER-BALLENGER
180mm



TVS-58-2445 - 2448
MICRO-HALSTED
125mm



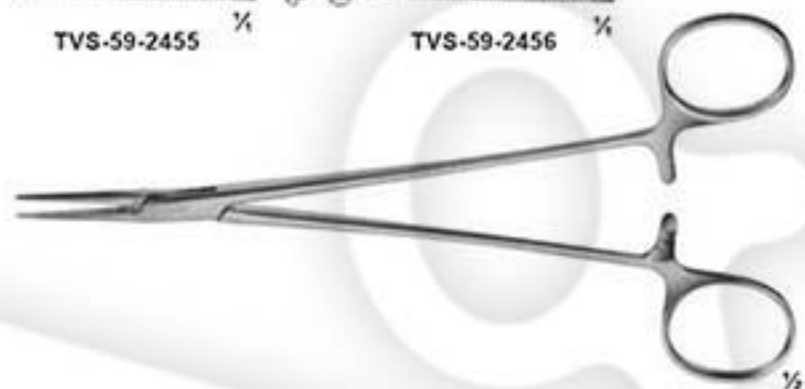
TVS-58-2431 - 2438
FOERSTER-BALLENGER
240mm



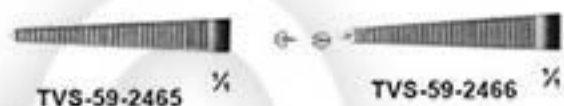
TVS-58-2449 - 2452
HALSTED-MOSQUITO
125mm

STRAIGHT
TVS-58-2431 - 150mm
TVS-58-2432 - 180mm
TVS-58-2433 - 200mm
TVS-58-2434 - 245mm

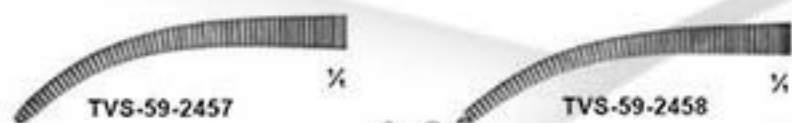
CURVED
TVS-58-2435 - 150mm
TVS-58-2436 - 180mm
TVS-58-2437 - 200mm
TVS-58-2438 - 245mm



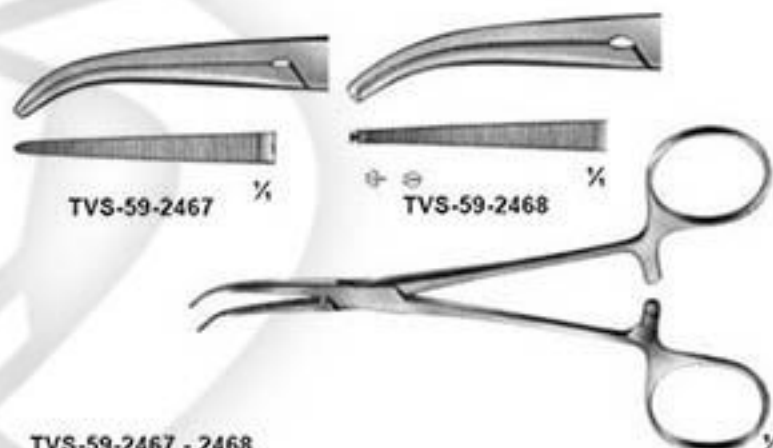
TVS-59-2453 - 2456
HALSTED
185mm



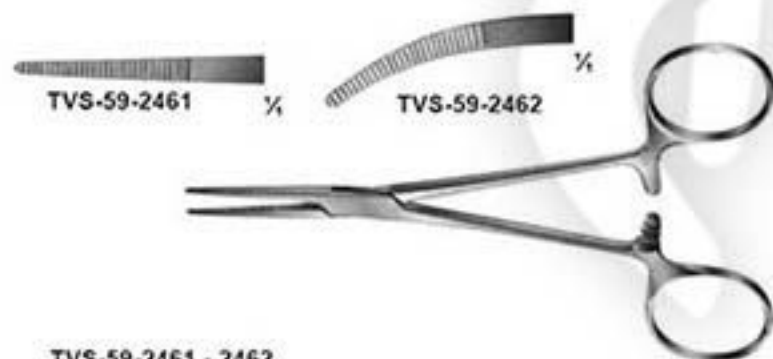
TVS-59-2463 - 2466
BABY-CRILE
140mm



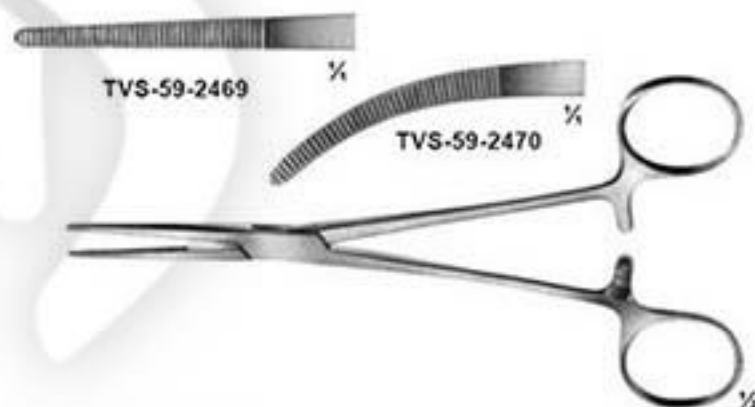
TVS-59-2457 - 2460
HALSTED-MOSQUITO
200mm



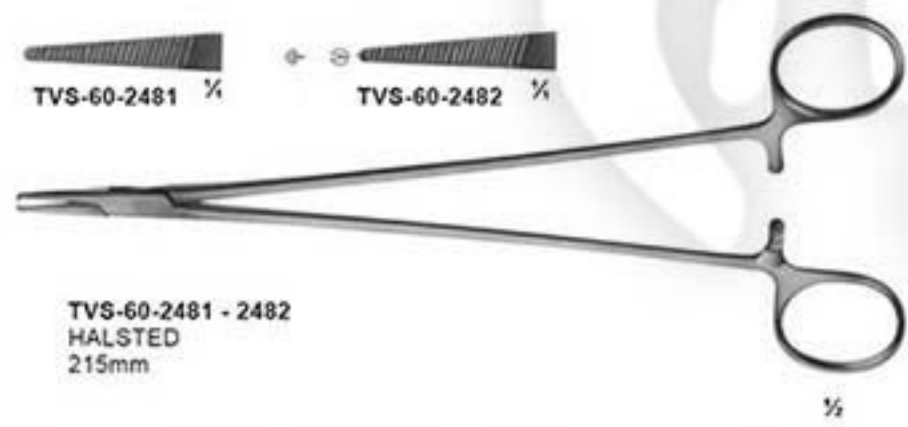
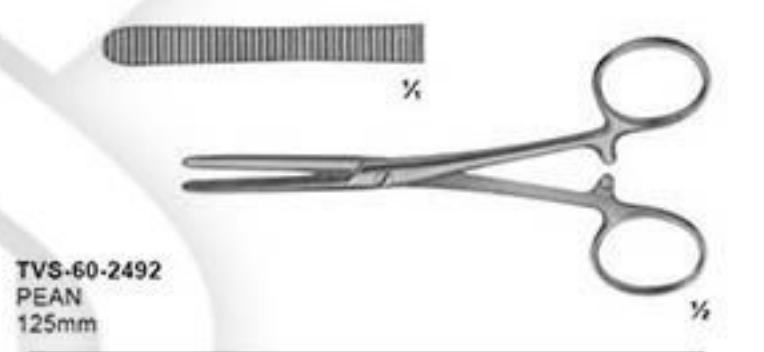
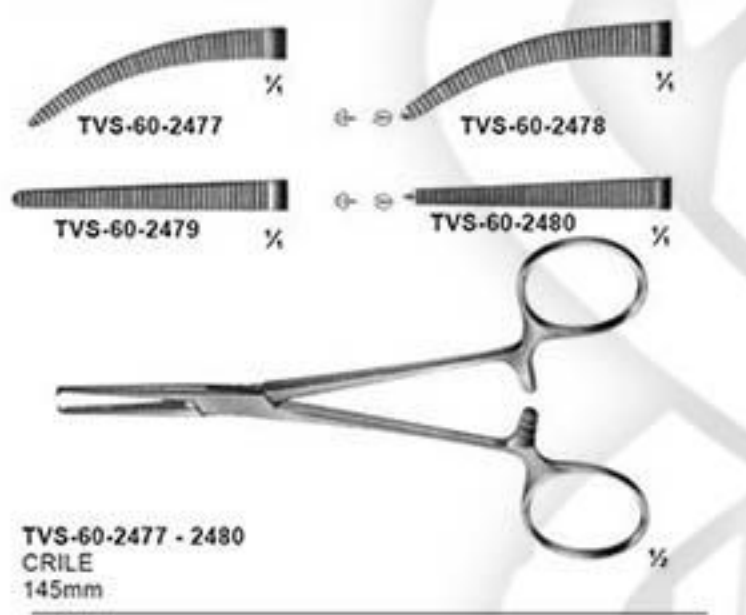
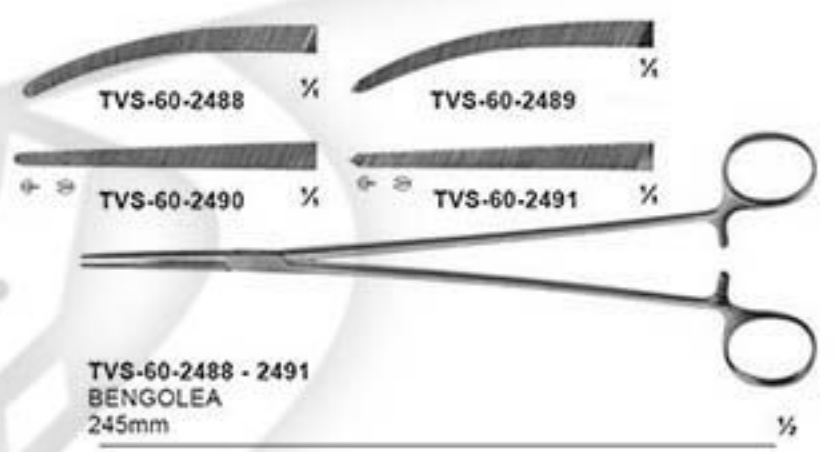
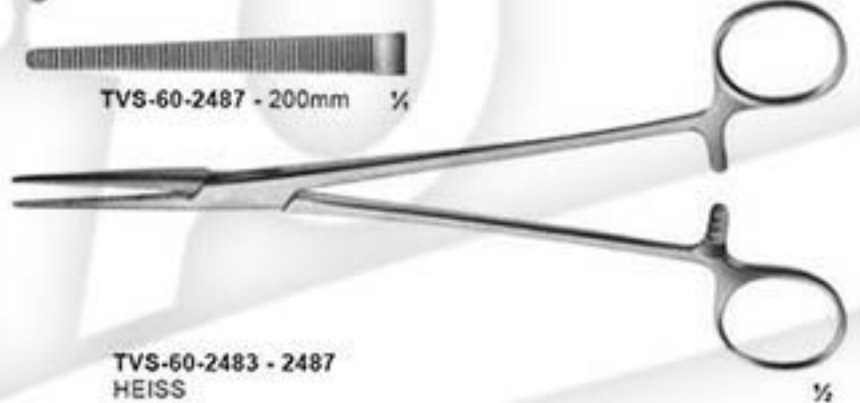
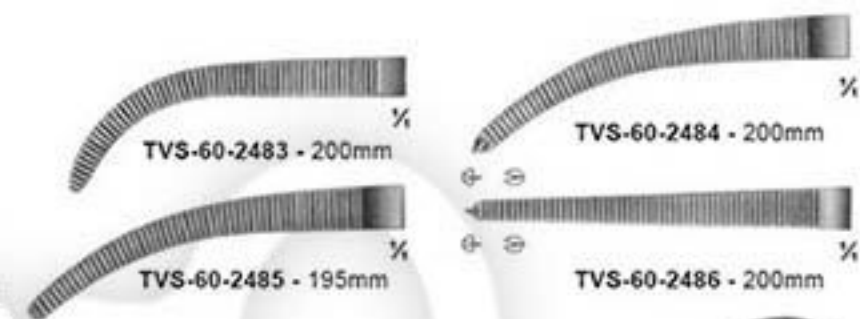
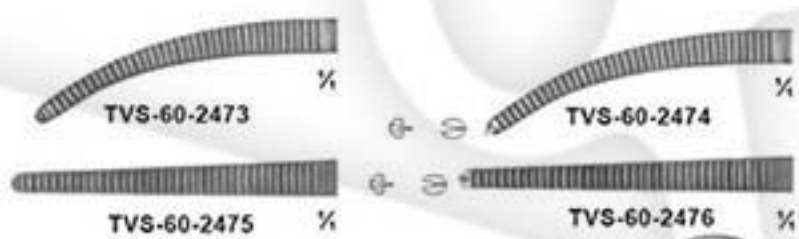
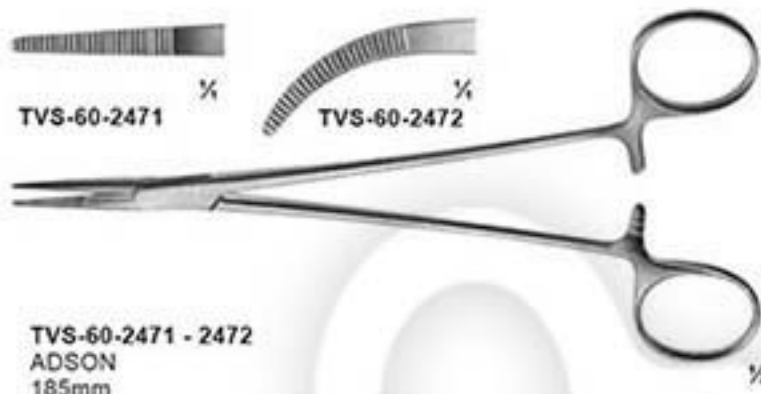
TVS-59-2467 - 2468
DANDY
Curved Sideways
140mm



TVS-59-2461 - 2462
KELLY
145mm

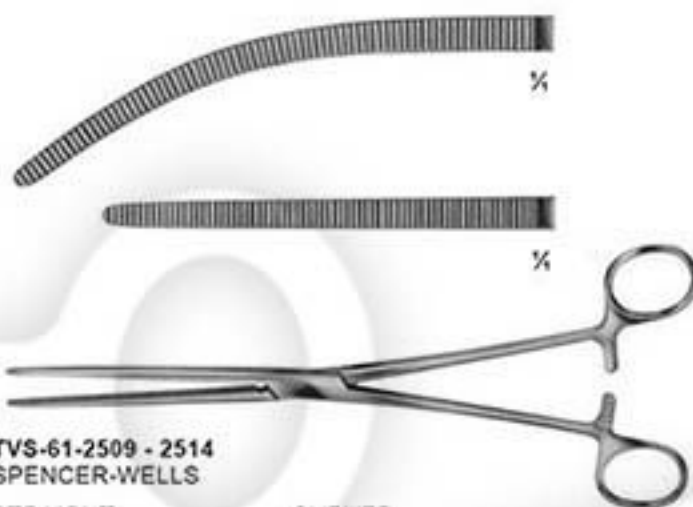


TVS-59-2469 - 2470
RANKIN
160mm



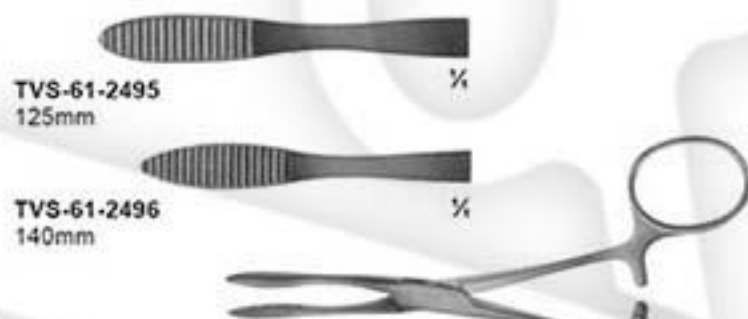


TVS-61-2494
CRAFOORD
245mm



TVS-61-2509 - 2514
SPENCER-WELLS

STRAIGHT	CURVED
TVS-61-2509 - 240mm	TVS-61-2512 - 240mm
TVS-61-2510 - 260mm	TVS-61-2513 - 260mm
TVS-61-2511 - 280mm	TVS-61-2514 - 280mm



TVS-61-2495
125mm

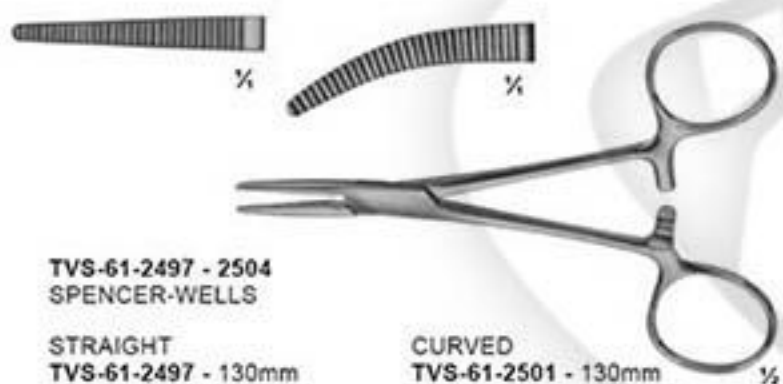
TVS-61-2496
140mm

TVS-61-2496 - 2496
PEAN



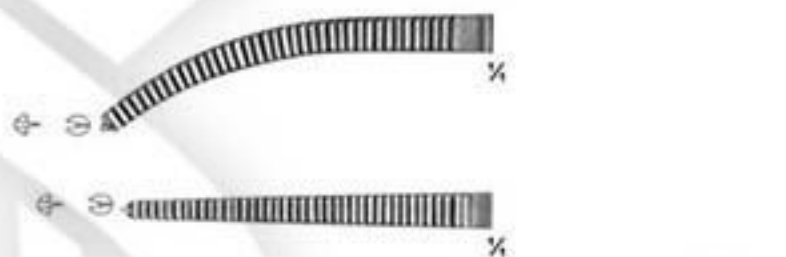
TVS-61-2515 - 2524
Rochester-Pean

STRAIGHT	CURVED
TVS-61-2515 - 160mm	TVS-61-2520 - 160mm
TVS-61-2516 - 185mm	TVS-61-2521 - 185mm
TVS-61-2517 - 200mm	TVS-61-2522 - 200mm
TVS-61-2518 - 225mm	TVS-61-2523 - 225mm
TVS-61-2519 - 240mm	TVS-61-2524 - 240mm



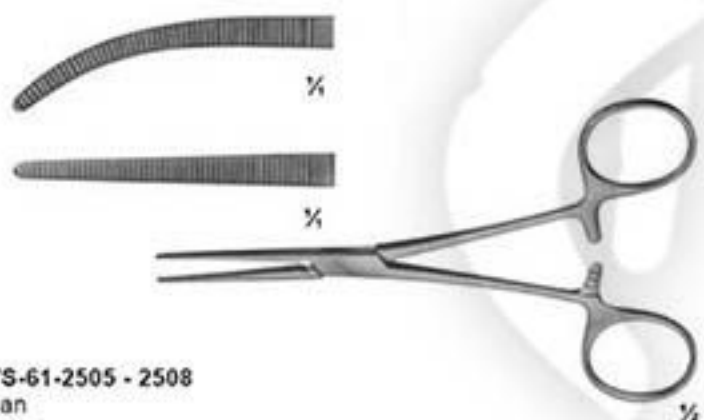
TVS-61-2497 - 2504
SPENCER-WELLS

STRAIGHT	CURVED
TVS-61-2497 - 130mm	TVS-61-2501 - 130mm
TVS-61-2498 - 150mm	TVS-61-2502 - 150mm
TVS-61-2499 - 175mm	TVS-61-2503 - 175mm
TVS-61-2500 - 200mm	TVS-61-2504 - 200mm



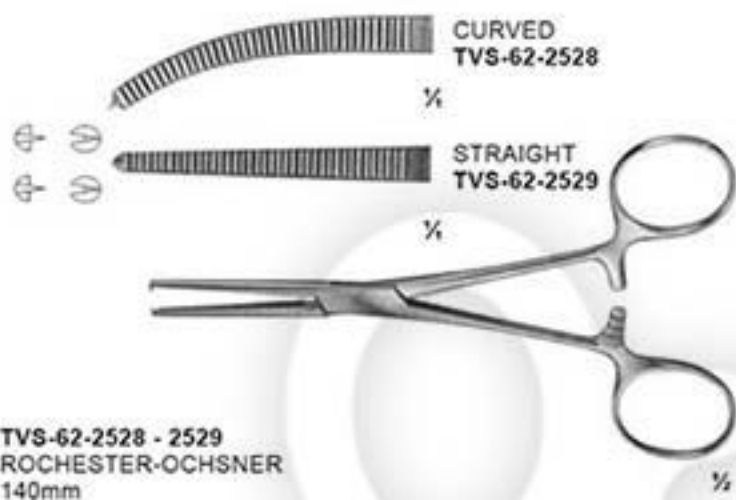
TVS-75-2525 - 2527
KOCHER

STRAIGHT	CURVED
TVS-61-2525 - 130mm	TVS-61-2527 - 140mm
TVS-61-2526 - 140mm	

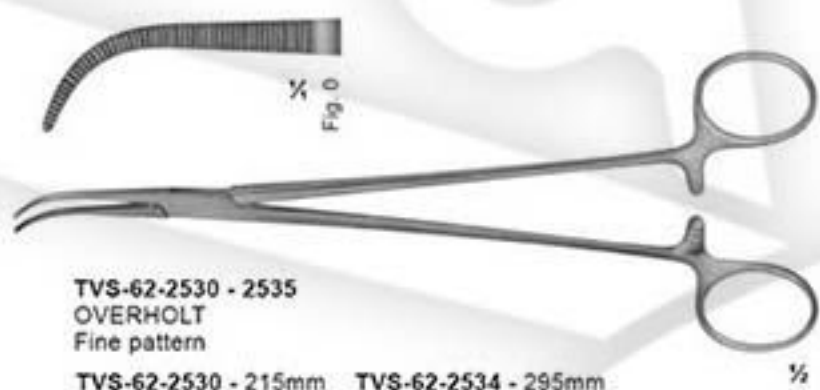


TVS-61-2505 - 2508
PEAN

STRAIGHT	CURVED
TVS-61-2505 - 130mm	TVS-61-2507 - 130mm
TVS-61-2506 - 140mm	TVS-61-2508 - 140mm



TVS-62-2528 - 2529
ROCHESTER-OCHSNER
140mm



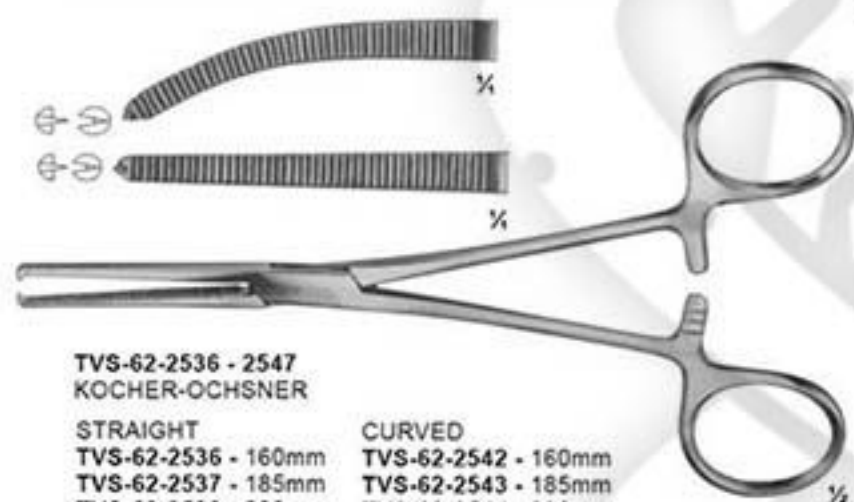
TVS-62-2530 - 2535
OVERHOLT
Fine pattern

- | | |
|---------------------|---------------------|
| TVS-62-2530 - 215mm | TVS-62-2534 - 295mm |
| TVS-62-2531 - 210mm | TVS-62-2535 - 300mm |
| TVS-62-2532 - 220mm | |
| TVS-62-2533 - 225mm | |



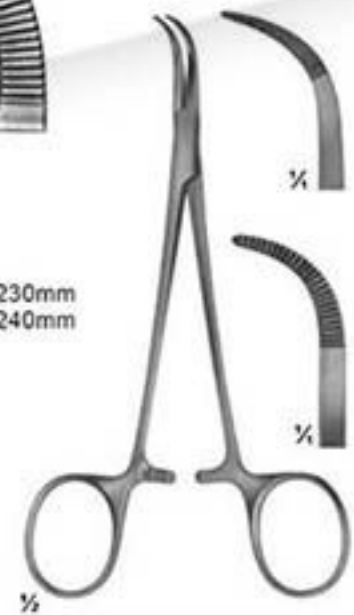
TVS-62-2552 - 2553
MOYNIHAN

TVS-62-2552 - 230mm
TVS-62-2553 - 240mm

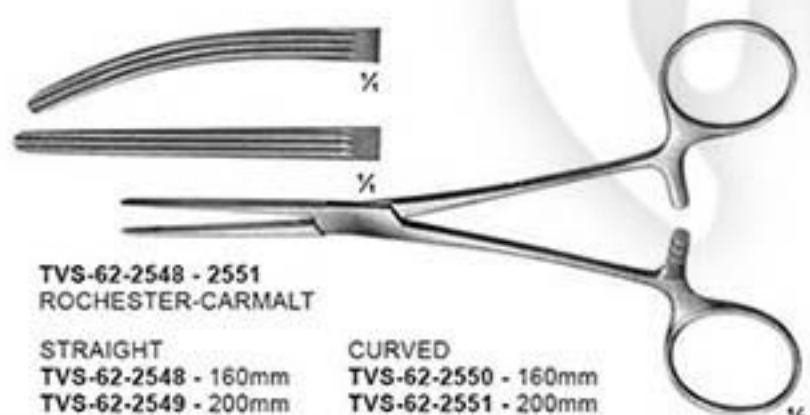


TVS-62-2536 - 2547
KOCHER-OCHSNER

- | | |
|---------------------|---------------------|
| STRAIGHT | CURVED |
| TVS-62-2536 - 160mm | TVS-62-2542 - 160mm |
| TVS-62-2537 - 185mm | TVS-62-2543 - 185mm |
| TVS-62-2538 - 200mm | TVS-62-2544 - 200mm |
| TVS-62-2539 - 225mm | TVS-62-2545 - 225mm |
| TVS-62-2540 - 240mm | TVS-62-2546 - 240mm |
| TVS-62-2541 - 260mm | TVS-62-2547 - 260mm |



TVS-62-2554 - 2555
BABY-MIXTER
TVS-62-2554 - 140mm
TVS-62-2555 - 180mm

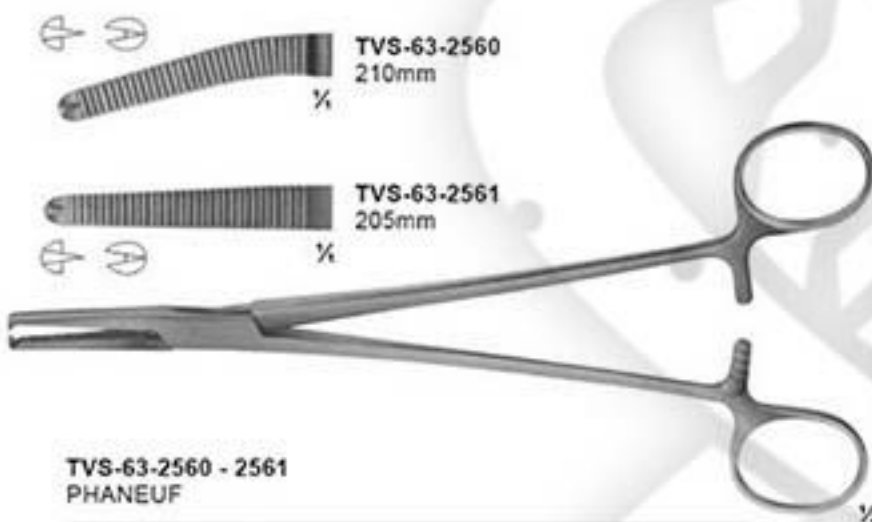
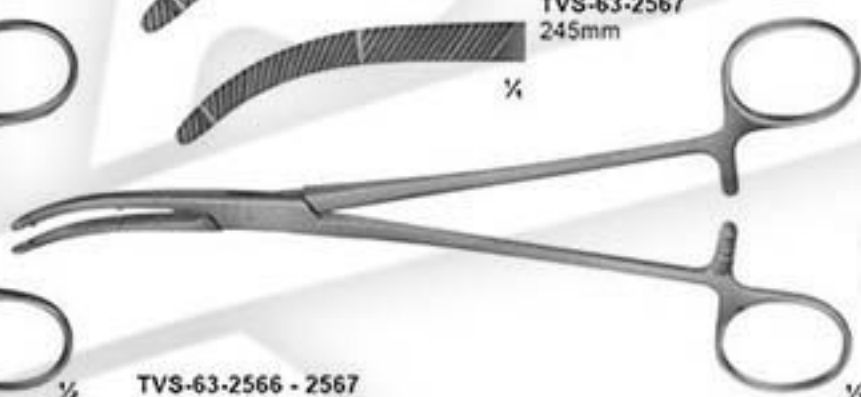
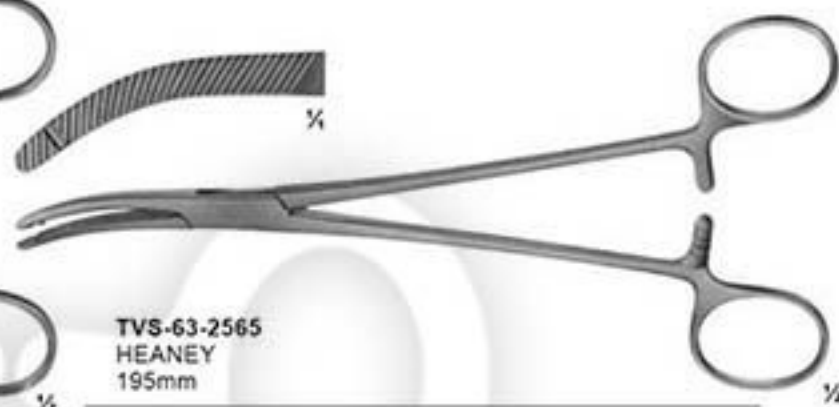


TVS-62-2548 - 2551
ROCHESTER-CARMALT

- | | |
|---------------------|---------------------|
| STRAIGHT | CURVED |
| TVS-62-2548 - 160mm | TVS-62-2550 - 160mm |
| TVS-62-2549 - 200mm | TVS-62-2551 - 200mm |



TVS-62-2556
OVERHOLT-MIXTER
205mm

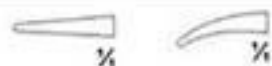


TVS-63-2568
MULLER
With Locking
Mechanism
145mm

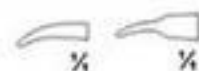
TVS-63-2569 TVS-63-2570



TVS-63-2569 - 2570
BARRAQUER
With Catch
120mm



TVS-63-2562
CASTROVIJO
With Catch
145mm



TVS-63-2563 - 2564
BARRAQUER
Without Catch

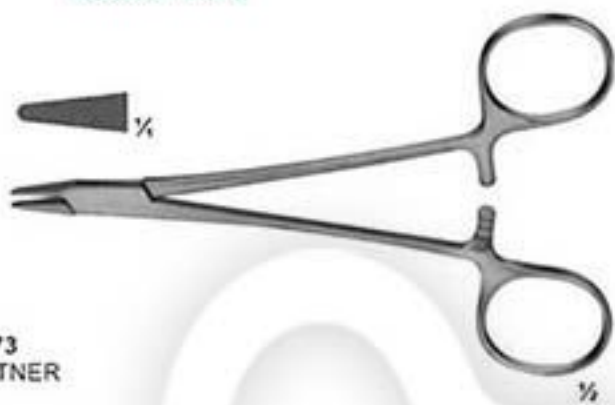
TVS-63-2563 - 115mm
TVS-63-2564 - 135mm



TVS-63-2571 TVS-63-2572



TVS-63-2571 - 2572
BARRAQUER
Without Catch
120mm



TVS-64-2573
BAUMGARTNER
145mm



TVS-64-2574
DERF
125mm



TVS-64-2575
Smooth Jaws



TVS-64-2576

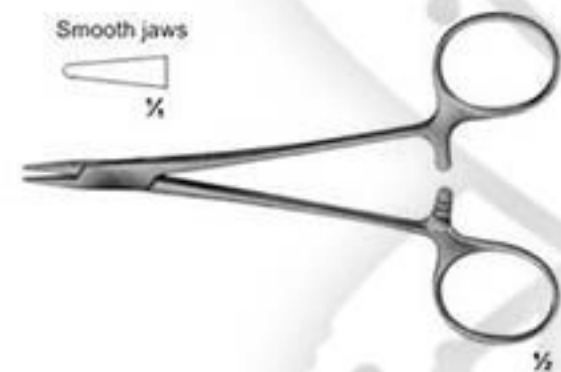


TVS-64-2575 - 2576
HALSEY
130mm

Smooth jaws



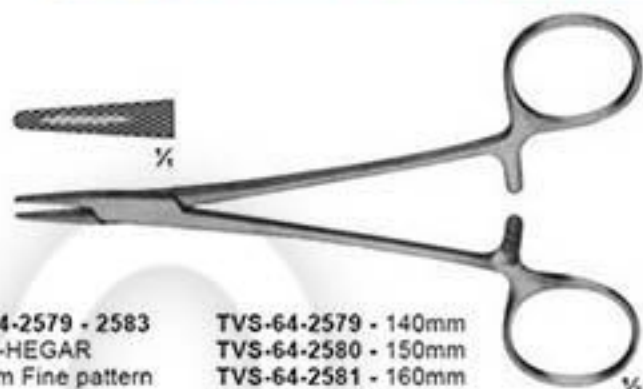
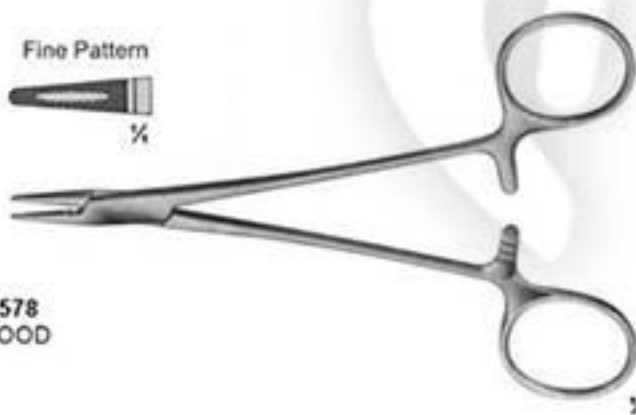
TVS-64-2577
WEBSTER
125mm



Fine Pattern

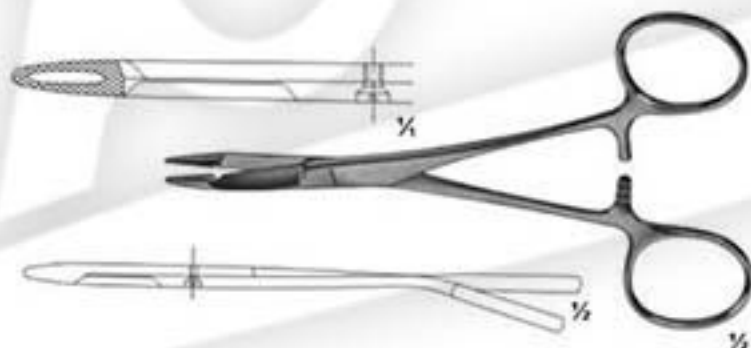


TVS-64-2578
CRILE-WOOD
150mm



TVS-64-2579 - 2583
MAYO-HEGAR
Medium Fine pattern

TVS-64-2579 - 140mm
TVS-64-2580 - 150mm
TVS-64-2581 - 160mm
TVS-64-2582 - 180mm
TVS-64-2583 - 200mm



TVS-64-2584 - 2585
HEGAR_OLSEN
Needle Holder With Scis

TVS-64-2584 - 140mm
TVS-64-2585 - 165mm
TVS-64-2586 - 185mm



TVS-64-2587 - 2588
MATHIEU-STILLE
Very Heavy Models

TVS-64-2587 - 175mm
TVS-64-2588 - 200mm

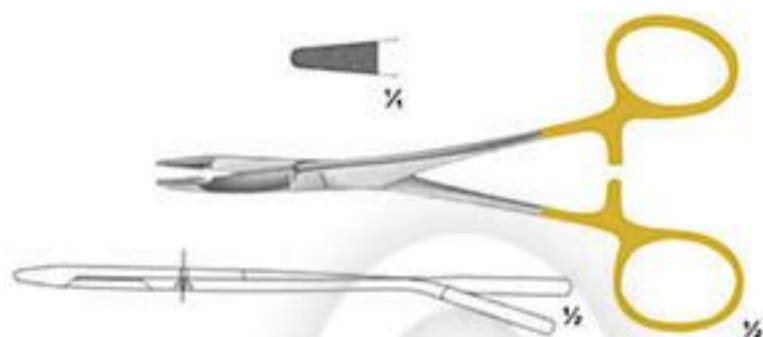


TVS-64-2589 - 2591
MATHIEU

TVS-64-2589 - 140mm
TVS-64-2590 - 170mm
TVS-64-2591 - 200mm



TVS-64-2592
BOYNTON
125mm



TVS-65-2593 - 2595
HEGAR-OLSEN
Needle holder with Scissors

TVS-65-2593 - 140mm
TVS-65-2594 - 185mm
TVS-65-2595 - 165mm

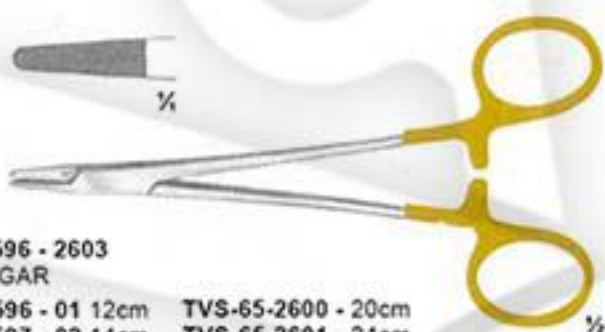


TVS-65-2614 - 2615
LANGHALS

TVS-65-2614 - 20cm
TVS-65-2615 - 25cm

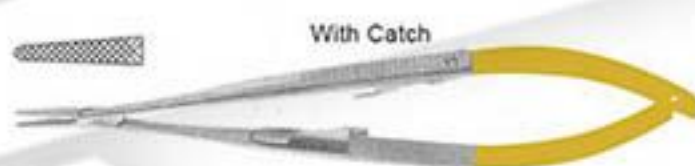


TVS-65-2616
LICHTENBERG
20cm



TVS-65-2596 - 2603
MAYO-HEGAR

TVS-65-2596 - 01 12cm
TVS-65-2597 - 02 14cm
TVS-65-2598 - 03 16cm
TVS-65-2599 - 18cm
TVS-65-2600 - 20cm
TVS-65-2601 - 24cm
TVS-65-2602 - 26cm
TVS-65-2603 - 30cm



TVS-65-2617 - 2618
CASTROVIEJO

TVS-65-2617 - 14cm
TVS-65-2618 - 17cm



TVS-65-2604 - 2606
MATHIEU

TVS-65-2604 - 17cm
TVS-65-2605 - 20cm
TVS-65-2606 - 23cm



TVS-65-2618 - 2621
CASTROVIEJO

TVS-65-2619 - 14cm STR
TVS-65-2620 - 17cm STR
TVS-65-2621 - 14cm CVD
TVS-65-2622 - 14cm CVD



TVS-65-2607 - 2609
MATHIEU

TVS-65-2607 - 14cm
TVS-65-2608 - 17cm
TVS-65-2609 - 20cm



TVS-65-2622 - 2623
BARRAQUER

TVS-65-2623 - 11.5cm
TVS-65-2624 - 14cm



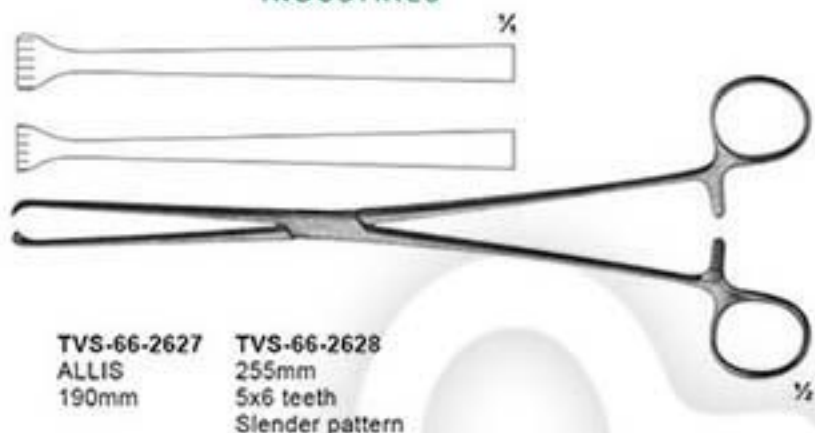
TVS-65-2610 - 2613
MATHIEU-KOUCHER

TVS-65-2610 - 14cm
TVS-65-2611 - 17cm
TVS-65-2612 - 20cm
TVS-65-2613 - 24cm



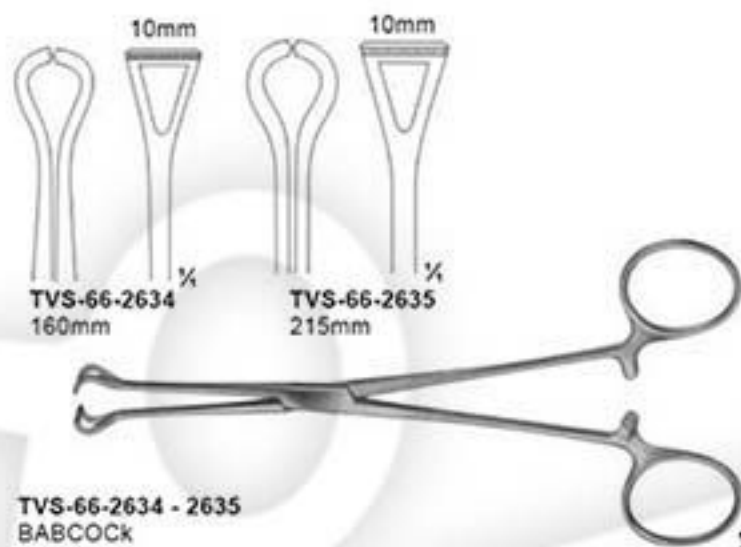
TVS-65-2625 - 2626
BARRAQUER

TVS-65-2625 - 11.5cm
TVS-65-2626 - 14cm



TVS-66-2627 ALLIS
190mm

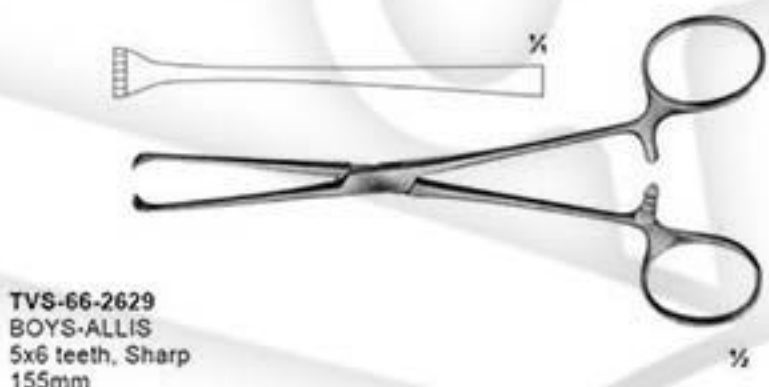
TVS-66-2628
255mm
5x6 teeth
Slender pattern



TVS-66-2634
160mm

TVS-66-2635
215mm

TVS-66-2634 - 2635
BABCOCK

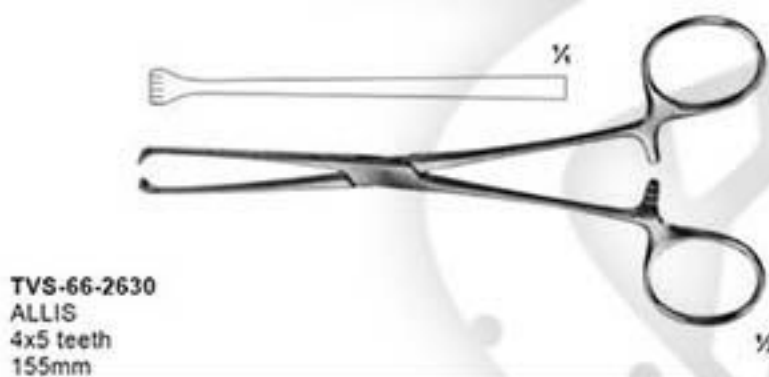


TVS-66-2629
BOYS-ALLIS
5x6 teeth, Sharp
155mm

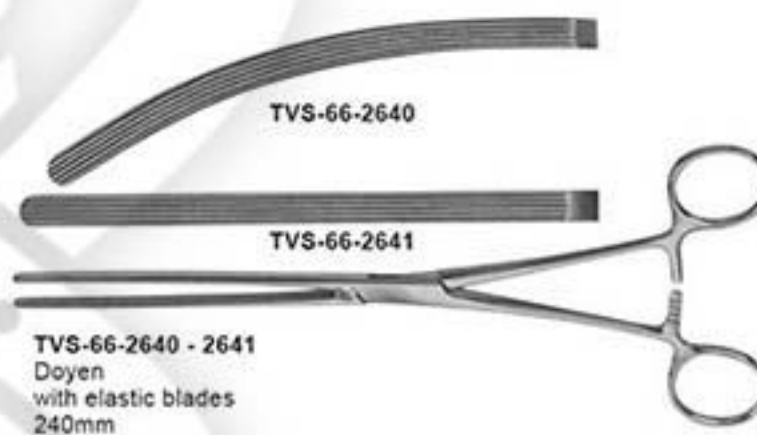


TVS-66-2636 - 2639
KOCHER
with Elastic blades

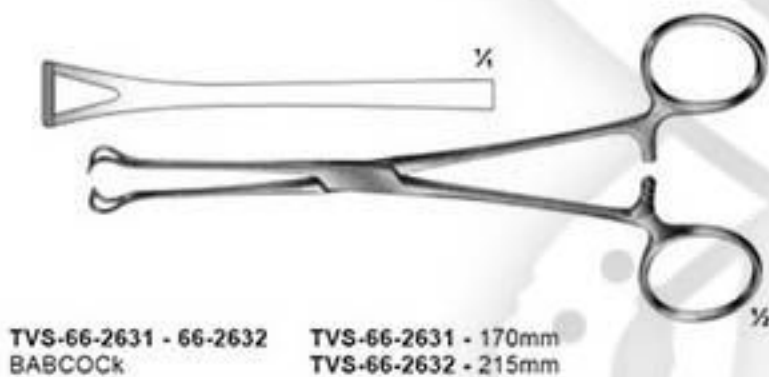
TVS-66-2636 - 210mm STR
TVS-66-2637 - 230mm STR
TVS-66-2638 - 210mm CVD
TVS-66-2639 - 230mm CVD



TVS-66-2630
ALLIS
4x5 teeth
155mm

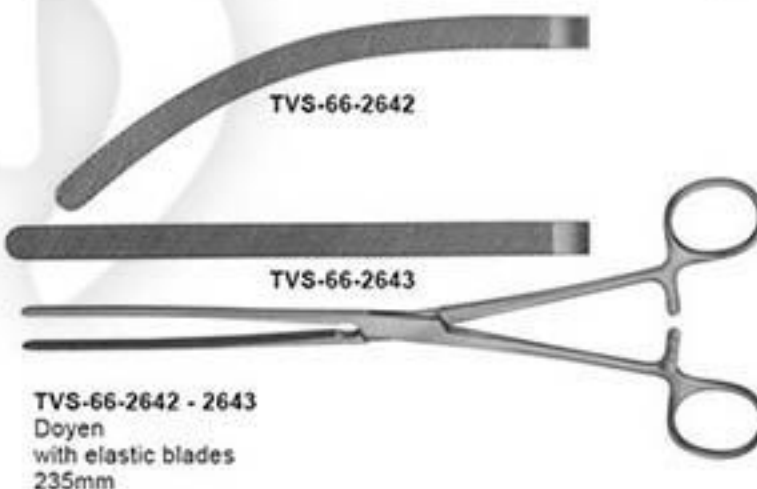


TVS-66-2640 - 2641
Doyen
with elastic blades
240mm



TVS-66-2631 - 66-2632
BABCOCK

TVS-66-2631 - 170mm
TVS-66-2632 - 215mm



TVS-66-2642 - 2643
Doyen
with elastic blades
235mm



TVS-66-2633
BABCOCK
155mm

Atraumata

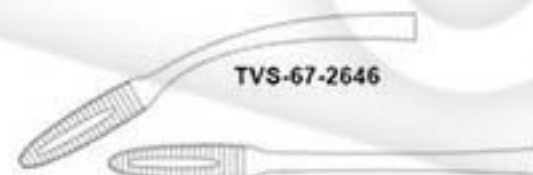


TVS-67-2644



TVS-67-2645

TVS-67-2644 - 2645
DOYEN
with elastic blades
230mm



TVS-67-2646



TVS-67-2647

TVS-67-2646 - 2647
MAIER
With Ratchet
265mm



TVS-67-2648 - 250mm



TVS-67-2649 - 260mm

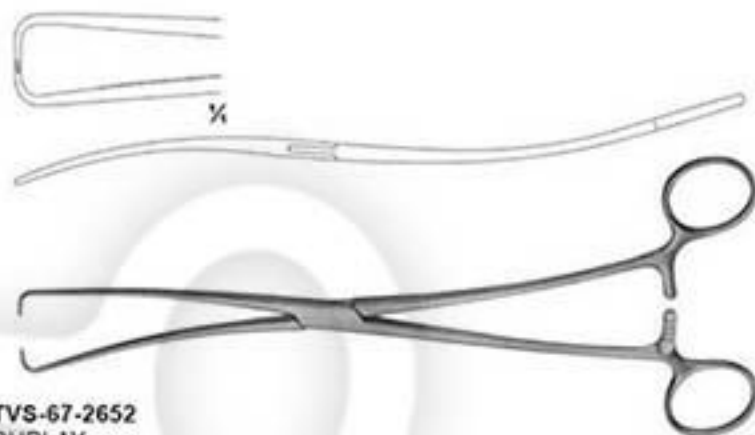
TVS-67-2648 - 2649
BOZEMANN



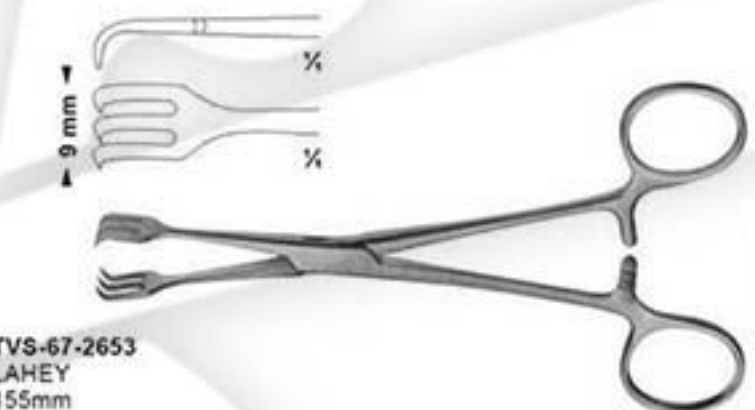
TVS-67-2650
POZZI
Heavy type
255mm



TVS-67-2651
SCHROEDER
250mm



TVS-67-2652
DUPLAY
250mm



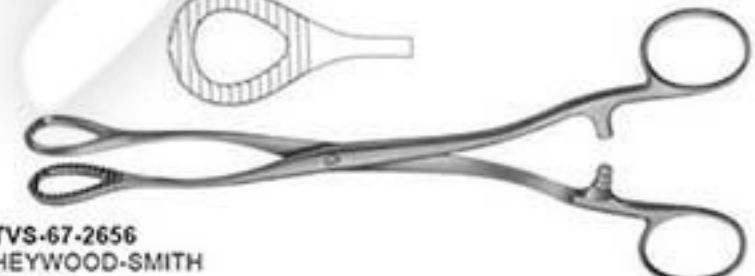
TVS-67-2653
LAHEY
155mm



TVS-67-2654
SCHROEDER
270mm



TVS-67-2655
TEALE
225mm



TVS-67-2656
HEYWOOD-SMITH
200mm



TVS-68-2657
LUCAE Ear Dressing Forceps
 Serrated, Bayonet
 Length: 14cm / 5^{1/2}"



TVS-68-2663
Tischler Cervical Biopsy Forceps
 220mm



TVS-68-2658 - 2660
TROELTSCH (WILDE) Ear Dressing Forceps Angle

TVS-68-2658 - 11cm
TVS-68-2659 - 12cm
TVS-68-2660 - 14cm



TVS-68-2664 - 2666
HARTMANN Alligator Ear Polypus Forceps Serrated

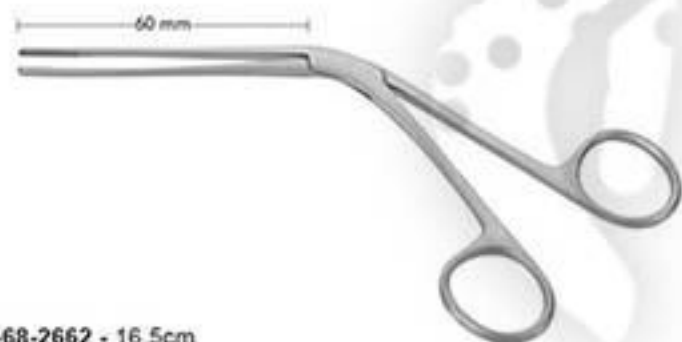
TVS-68-2664 - 8.5cm
TVS-68-2665 - 14cm
TVS-68-2666 - 16.5cm



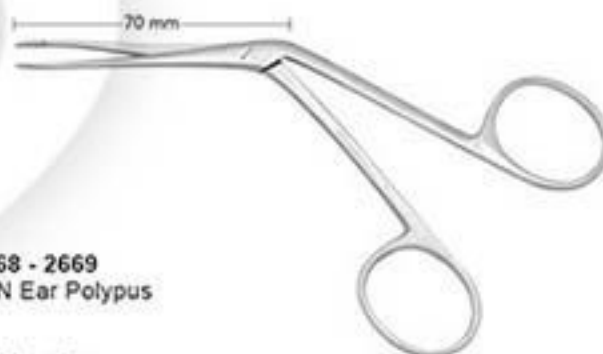
TVS-68-2661 - 13cm
TROELTSCH (WILDE) Ear Dressing Forceps Serrated cross action



TVS-68-2667 - 12cm
LITTAUER Ear Polypus Forceps



TVS-68-2662 - 16.5cm
TILLEY Ear Polypus Forceps



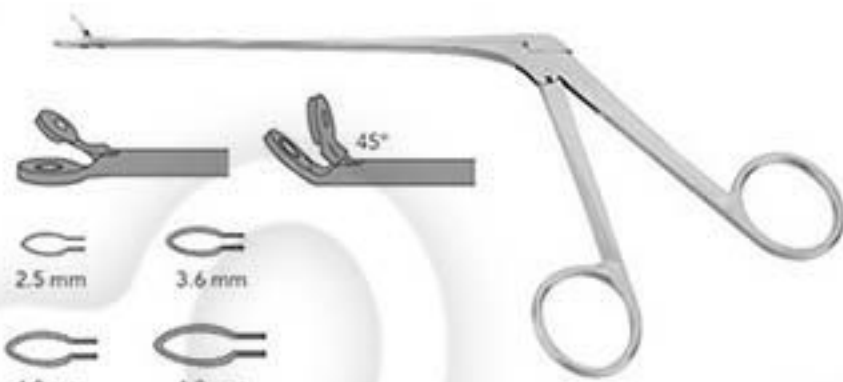
TVS-68-2668 - 2669
HARTMANN Ear Polypus Forceps

TVS-68-2668 - 12cm
TVS-68-2669 - 14cm



TVS-69-2670 - 2673
TAKAHASHI (Watson-Williams)
 Nasal Cutting Forceps
 Working length 12cm/4^{3/4}"

STRAIGHT
TVS-69-2670 - 3 x 10mm
TVS-69-2671 - 4 x 10mm
45° UPWARDS
TVS-69-2672 - 3 x 10mm
TVS-69-2673 - 4 x 10mm



TVS-69-2692 - 2703
BLAKESLEY Nasal
 Through Cutting Forceps
 Shaft length 12cm/4^{3/4}"

STRAIGHT
TVS-69-2692 - 2.5mm
TVS-69-2693 - 3.0mm
TVS-69-2694 - 3.6mm
TVS-69-2695 - 4.2mm
TVS-69-2696 - 4.8mm
TVS-69-2697 - 5.6mm

45° UPWARDS
TVS-69-2698 - 2.5mm
TVS-69-2699 - 3.0mm
TVS-69-2700 - 3.6mm
TVS-69-2701 - 4.2mm
TVS-69-2702 - 4.8mm
TVS-69-2703 - 5.6mm



TVS-69-2674 - 2691
WEIL-BLAKESLEY (WILDE)
 Nasal Cutting Forceps
 Shaft length 12cm/4^{3/4}"

45° UPWARDS
TVS-69-2680 - 2.5mm
TVS-69-2681 - 3.0mm
TVS-69-2682 - 3.6mm
TVS-69-2683 - 4.2mm
TVS-69-2684 - 4.8mm
TVS-69-2685 - 5.6mm

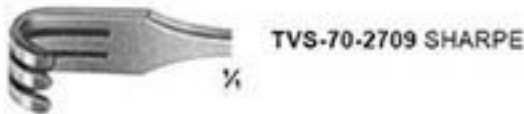
STRAIGHT
TVS-69-2674 - 2.5mm
TVS-69-2675 - 3.0mm
TVS-69-2676 - 3.6mm
TVS-69-2677 - 4.2mm
TVS-69-2678 - 4.8mm
TVS-69-2679 - 5.6mm

90° UPWARDS
TVS-69-2686 - 2.5mm
TVS-69-2687 - 3.0mm
TVS-69-2688 - 3.6mm
TVS-69-2689 - 4.2mm
TVS-69-2690 - 4.8mm
TVS-69-2691 - 5.6mm

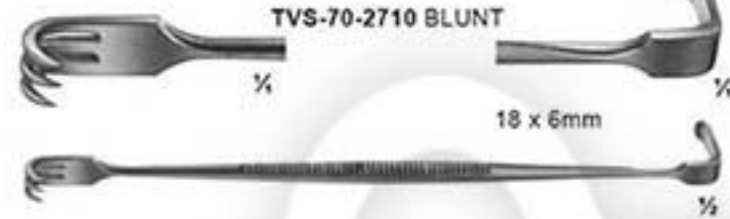


TVS-69-2704 - 2708
KERRISON Sphenoid
 Bone Punches
 Overall Length 20cm / 8"
 Working length 8.5cm 3^{1/4}"

TVS-69-2704 - 3.5mm
TVS-69-2705 - 4.0mm
TVS-69-2706 - 4.5mm
TVS-69-2707 - 5.0mm
TVS-69-2708 - 6.0mm



TVS-70-2709 SHARPE



TVS-70-2710 BLUNT

18 x 6mm

TVS-70-2709 - 2710
SENN-MILLER
165mm



TVS-70-2713
VOLKMANN
Sharp
220mm



TVS-70-2711-01-03
FARABEUZ
TVS-70-2711-01 - 120mm
TVS-70-2711-02 - 140mm
TVS-70-2711-03 - 150mm



TVS-70-2714 - 2719
LANGENBECK
210mm

TVS-70-2714 - 28x10mm
TVS-70-2715 - 28x14mm
TVS-70-2716 - 38x14mm
TVS-70-2717 - 28x16mm
TVS-70-2718 - 40x10mm
TVS-70-2719 - 40x13mm



TVS-70-2712
Cat Castration Hook 180mm



TVS-70-2720 - 2725
VOLKMANN
220mm



TVS-70-2726
JOSEPH
165mm



TVS-70-2730
GILLIES
180mm

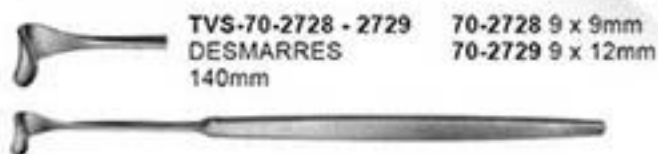


TVS-70-2727-01-02
LANGE Fistula Hook

TVS-70-2727-01 - 180mm
TVS-70-2727-02 - 230mm



TVS-70-2731
SNOKE HOOK
200mm



TVS-70-2728 - 2729
DESMARRES
140mm
70-2728 9 x 9mm
70-2729 9 x 12mm



TVS-70-2732
CUSHING
250mm



TVS-71-2733
WEITLANER
Semi-Sharp
110mm



TVS-71-2738
WEITLANER
Blunt
130mm



TVS-71-2734
WEITLANER
Sharp
110mm



TVS-71-2739
WEITLANER
Semi-Sharp
130mm



TVS-71-2735
JANSEN
100mm



TVS-71-2740
WEITLANER
Sharp
130mm



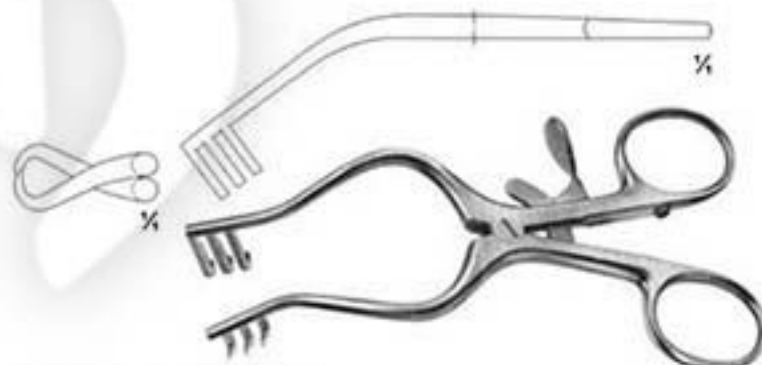
TVS-71-2736
ALM Retractor



TVS-71-2741
WEITLANER
Blunt
110mm



TVS-71-2737
WEITLANER
Sharp
130mm



TVS-71-2742
WEITLANER
Blunt
130mm

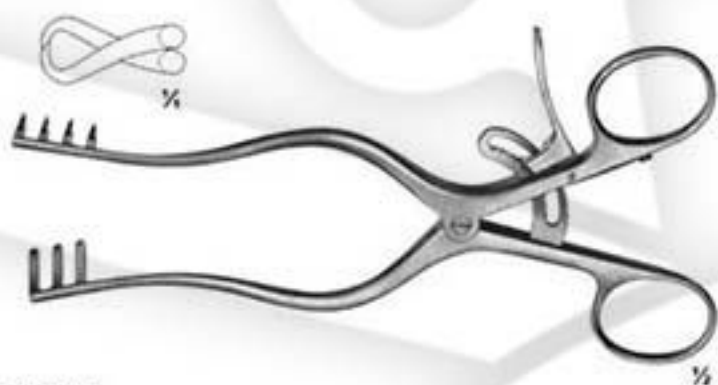
TVS-71-2743
WEITLANER
Sharp
130mm



TVS-72-2744
PLEASTER
 Blunt
 110mm



TVS-72-2748
BECKMANN-EATON
 Sharp
 320mm



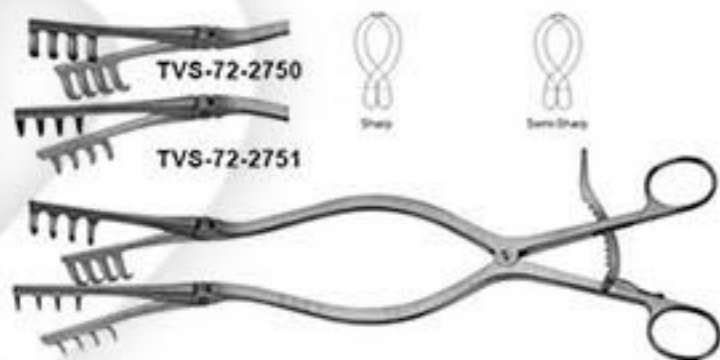
TVS-72-2745
WEITLANER
 Sharp
 165mm



TVS-72-2749
ADSON
 Semi-Sharp
 320mm



TVS-72-2746
ADSON
 Sharp
 265mm



TVS-72-2750 - 2751
BECKMANN-ADSON
 Sharp
 310mm



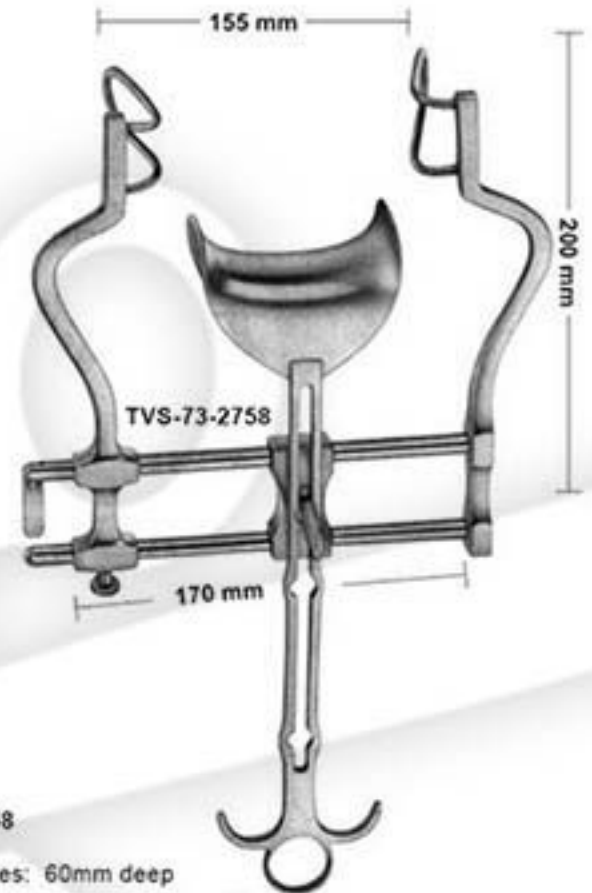
TVS-72-2747
JACKSON BURROWS
 Retractor, blunt
 185mm



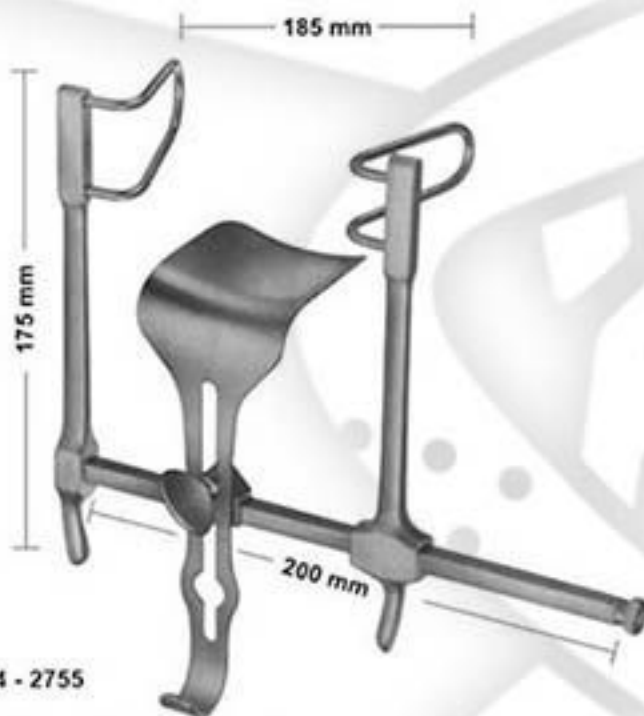
TVS-72-2752
GELPI
 Vaginal Retractor
 135mm



TVS-73-2753
GOSSET
Blades: 55mm deep



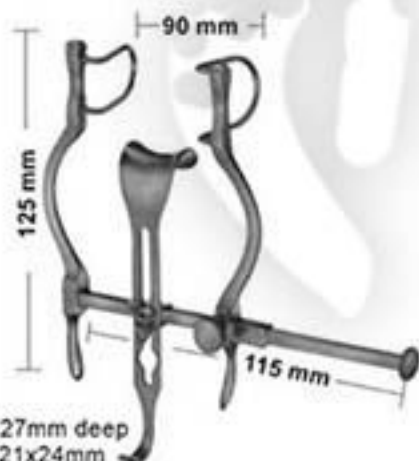
TVS-73-2758
BALFOUR
Lateral blades: 60mm deep
TVS-73-2759
Center blades: 47x80mm



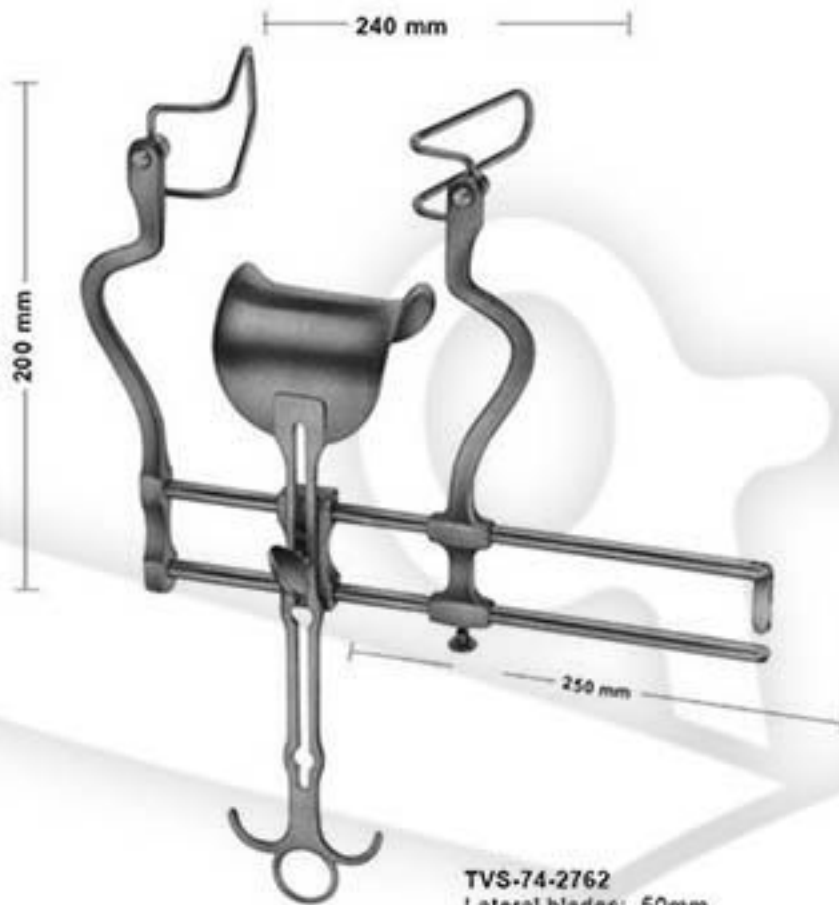
TVS-73-2754 - 2755
GOSSET
TVS-73-2754 Lateral blades: 58mm deep
TVS-73-2755 Center blades: 59x57mm



TVS-73-2760
BALFOUR
Lateral blades: 105mm deep
TVS-73-2761
Center blades: 107x59mm



TVS-73-2756 - 2757
BALFOUR-BABY
TVS-73-2756 Lateral blades: 27mm deep
TVS-73-2757 Center blades: 21x24mm



TVS-74-2762 - 2763
BALFOUR
Spreader only

TVS-74-2762
Lateral blades: 50mm
Center blades: 47x80mm

TVS-74-2763
Lateral blades: 60mm
Center blades: 62x76mm



TVS-74-2768 - 2770
GRAVE

TVS-74-2768 - 75x20mm
TVS-74-2769 - 75x20mm
TVS-74-2770 - 75x20mm



TVS-74-2771 - 2773
CUSCO Flat(duck beak)

TVS-74-2771 - 80x32mm
TVS-74-2772 - 90x37mm
TVS-74-2773 - 115x37mm



TVS-74-2764 - 2766
KILLIAN
for Children
145 mm

TVS-74-2764
90mm
TVS-74-2765
70mm
TVS-74-2766
50mm



TVS-74-2774 - 2776
CUSCO
Swiss pattern features:
long and narrow

TVS-74-2774 - 92x23-25mm
TVS-74-2775 - 100x25-27mm
TVS-74-2776 - 110x27-30mm



TVS-74-2767
SIMS
160mm



TVS-74-2777 - 2779
SIMS

TVS-74-2777 - 70x26mm / 75x30mm / 125mm
TVS-74-2778 - 75x30mm / 80x35mm / 150mm
TVS-74-2779 - 80x36mm / 90x40mm / 175mm



TVS-75-2780 - 2782
HARTMANN Nasal Speculas
TVS-75-2780 - 16.5cm
TVS-75-2781 - 16.5cm
TVS-75-2782 - 16.5cm



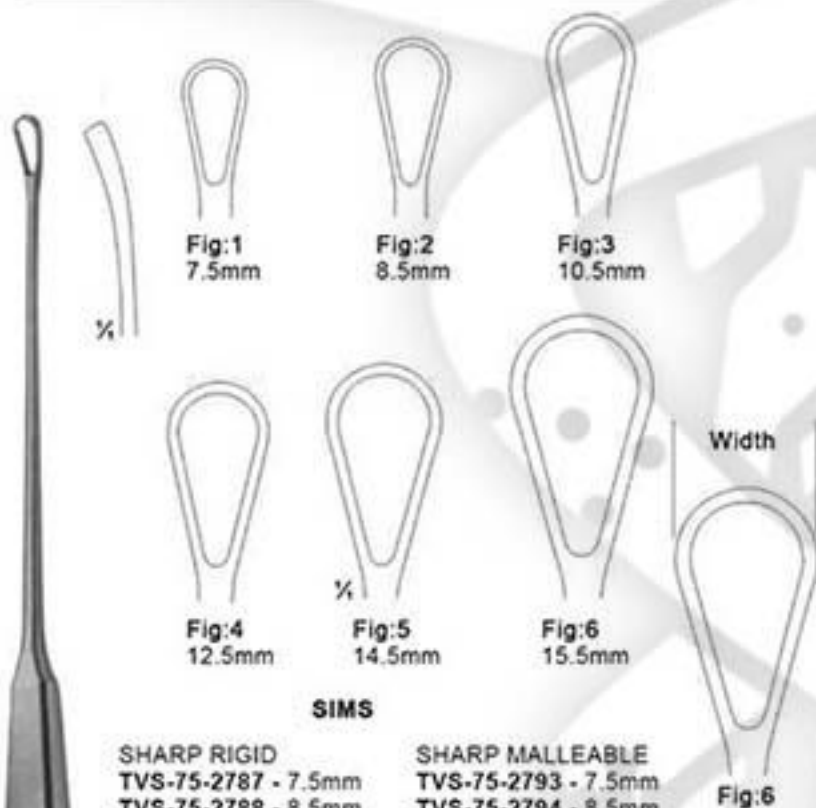
TVS-75-2805 - 2807
VIENNA Nasal Specula
TVS-75-2805 - 14cm Infant
TVS-75-2806 - 14cm Child
TVS-75-2807 - 14cm Adult



TVS-75-2783 - 2786
KILLIAN Nasal Speculas
Lenght 13cm
TVS-75-2783 - 35mm
TVS-75-2784 - 50mm
TVS-75-2785 - 75mm
TVS-75-2786 - 90mm



TVS-75-2808
YANKAUER
with especially large
central bore, 4.8mm
diam.
285mm



SIMS

SHARP RIGID
TVS-75-2787 - 7.5mm
TVS-75-2788 - 8.5mm
TVS-75-2789 - 10.5mm
TVS-75-2790 - 12.5mm
TVS-75-2791 - 14.5mm
TVS-75-2792 - 15.5mm

SHARP MALLEABLE
TVS-75-2793 - 7.5mm
TVS-75-2794 - 8.5mm
TVS-75-2795 - 10.5mm
TVS-75-2796 - 12.5mm
TVS-75-2797 - 14.5mm
TVS-75-2798 - 15.5mm

BLUNT RIGID
TVS-75-2799 - 7.5mm
TVS-75-2800 - 8.5mm
TVS-75-2801 - 10.5mm
TVS-75-2802 - 12.5mm
TVS-75-2803 - 14.5mm
TVS-75-2804 - 15.5mm

TVS-75-2787 - 2792 = Sharp Rigid
TVS-75-2793 - 2798 = Sharp Malleable
TVS-75-2799 - 2804 = Blunt Rigid

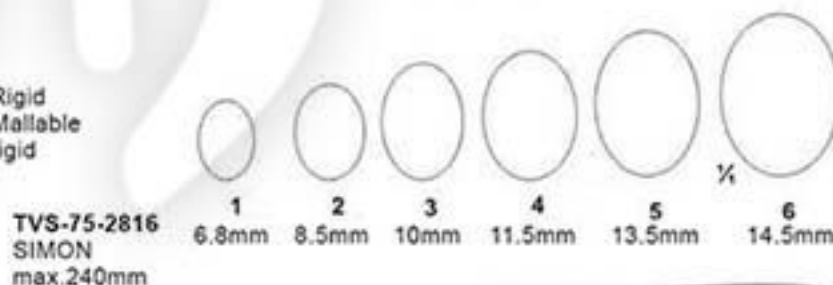
TVS-75-2787 - 2804
SIMS
max.255mm



TVS-75-2809 - 2813
FERGUSSON
with Finger cut-off and
Stylet, thumb piece
90° to curve, with
LUER hub
180mm
TVS-75-2809 - 2.0mm
TVS-75-2810 - 2.5mm
TVS-75-2811 - 3.0mm
TVS-75-2812 - 4.0mm
TVS-75-2813 - 5.0mm



TVS-75-2814 - 2815
FRAZIER
with Finger cut-off and
Stylet, thumb piece
90° to curve, with
LUER hub
190mm
TVS-75-2814 - 3mm
TVS-75-2815 - 5mm



TVS-75-2816
SIMON
max.240mm





TVS-76-3500
LANGENBECK
Length of blades
Resection knives
55mm



TVS-76-3513
LANGENBECK
Length of blade
115mm

TVS-76-3513-01
Metacarpal saw
235mm



TVS-76-3501
Length of blades
Periosteum knife
with respiratory
65mm



TVS-76-3514
SATTERLEE
Length of blade
200mm

TVS-76-3515
Spare saw blade,
Carbon steel
200mm



TVS-76-3502
Length of blades
Phalangeal knife
105mm



TVS-76-3516 - 3519
CHARRIERE
Length of blades
180mm
Spare saw blade
carbon steel
270mm

TVS-76-3516
Length of blade 180mm
TVS-76-3517
Carbon steel 270mm
TVS-76-3518
Length of blade 240mm
TVS-76-3519
Carbon steel 340mm



TVS-76-3503
CHARRIERE
length of blades
215mm
Complete with one saw
Blade each.

Spare saw blades, Carbon steel
TVS-76-3504 - 12mm
TVS-76-3505 - 20mm
TVS-76-3506 - 350mm
TVS-76-3506-01 - 350mm



TVS-76-3520
GIGLI
Handle



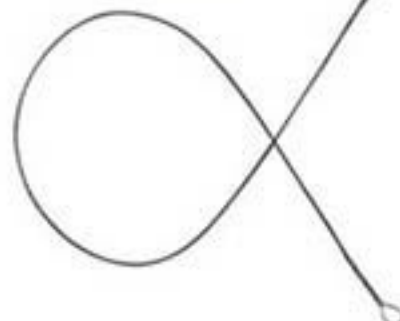
TVS-76-3507
RUST
Length of blades 235mm
complete with one saw
blade each and 2 saw blades
390mm

TVS-76-3508 - 235mm
TVS-76-3509 - Bow only
Spare saw blades, Carbon steel
TVS-76-3510 - 6mm
TVS-76-3511 - 8mm
TVS-76-3512 - 12mm
TVS-76-3512-01 - 20mm



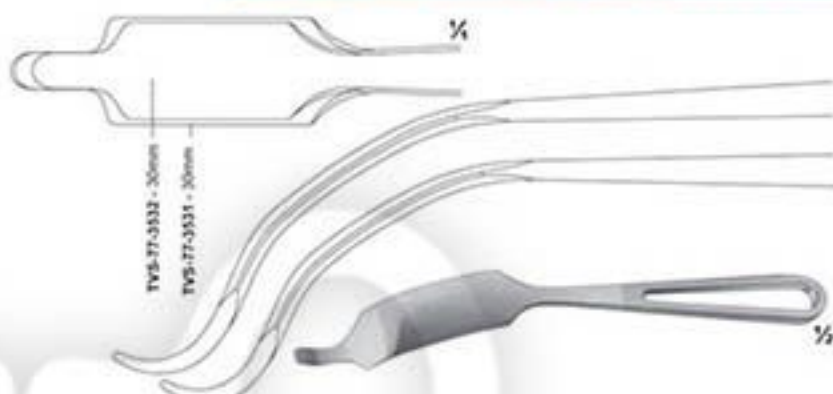
TVS-76-3521 - 3524
GIGLI

TVS-76-3521 - 300mm
TVS-76-3522 - 400mm
TVS-76-3523 - 500mm
fine, 6 wire twisted
TVS-76-3524 - 500mm
Coarse, 4 Wires twisted



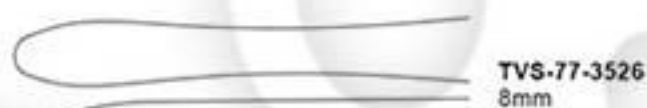


TVS-77-3525
LANGENBEECK
230mm



TVS-77-3531 - 2532
LANGE-HOHMANN
modif

TVS-77-3531 - 265mm
TVS-77-3532 - 280mm



TVS-77-3526
8mm



TVS-77-3527
10mm



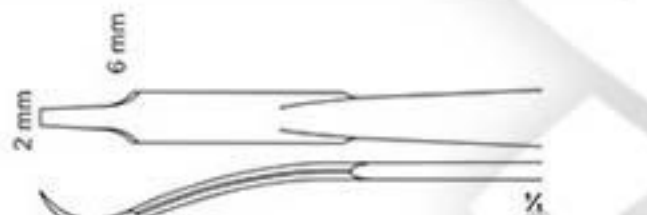
TVS-77-3533
LANGE-HOHMANN
250mm

TVS-77-3526 - 3527
LANGENBEECK
195mm



TVS-77-3534
LANE
255mm

TVS-77-3528
160mm



TVS-77-3529
160mm



TVS-77-3530
BUCK-GRAMCKO
150mm



TVS-77-3535
240mm



TVS-77-3536
WILLIGER
160mm



TVS-77-3537
FREER
Sharp 190mm



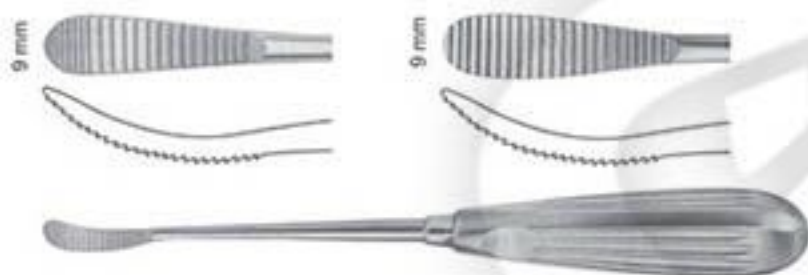
15 mm

TVS-78-3538
SEDILLOT
215mm



9 mm

TVS-78-3539
MALTZ
Down stroke
180mm



9 mm

9 mm

TVS-78-3540 - 3541

TVS-78-3540
AUFRICH
up Stroke

TVS-78-3541
Down Stroke
220mm



6,5 mm

7,5 mm

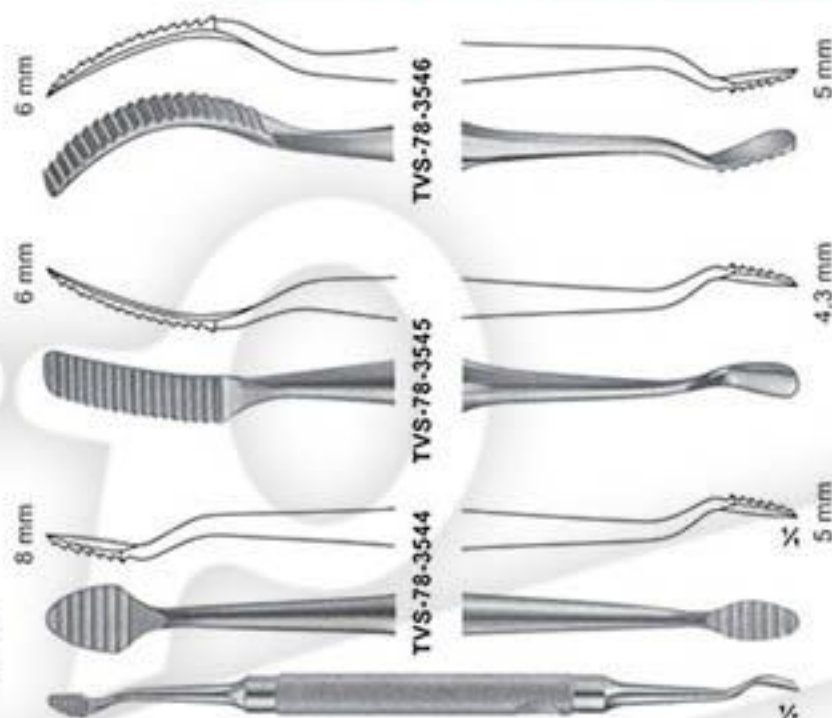
TVS-78-3542
FOMON
215mm



6,5 mm

7,5 mm

TVS-78-3543
FOMON
215mm



6 mm

6 mm

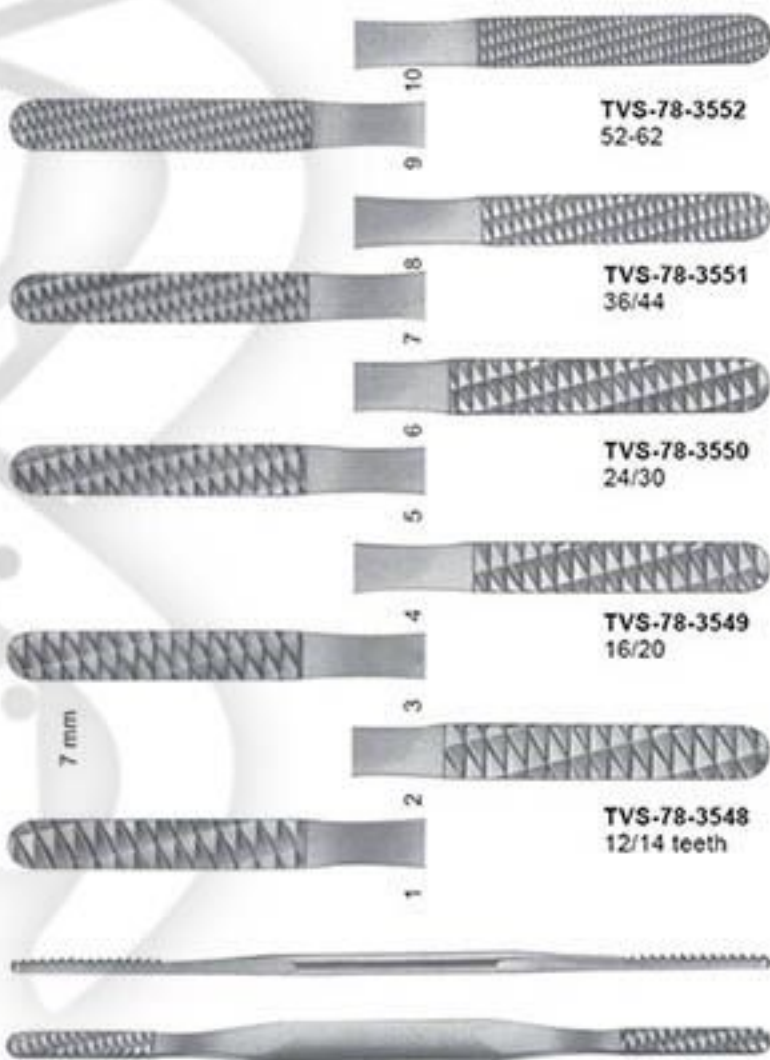
8 mm

5 mm

4,3 mm

5 mm

TVS-78-3544 - 3546
MILLER
180mm



10

9

8

7

6

5

4

3

2

1

TVS-78-3552
52/62

TVS-78-3551
36/44

TVS-78-3550
24/30

TVS-78-3549
16/20

TVS-78-3548
12/14 teeth

TVS-78-3547 - 3552
DUROGRIP

TVS-78-3547 - 205mm



TVS-79-3553
PUTTI
270mm



TVS-79-3554
295mm



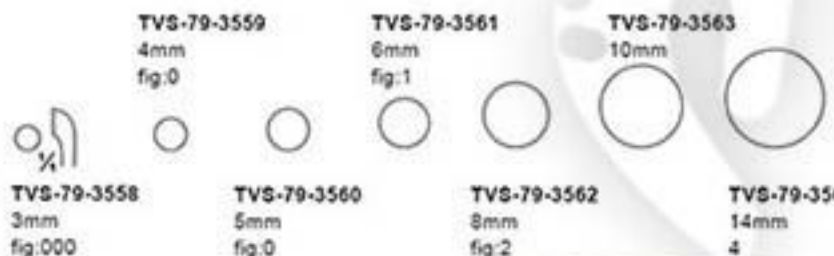
TVS-79-3555
220mm



TVS-79-3556
VOLKMANN
170mm



TVS-79-3557
VOLKMANN
145mm



TVS-79-3558 - 3564
VOLKMANN
165mm



TVS-79-3565 - 3569
LEMPERT
215mm



TVS-79-3570 - 140g
with interchangeable
palstic disks
185mm
TVS-79-3571
Pair of spare disks

TVS-79-3570 - 3571



TVS-79-3572 - 185g
MEAD
with interchangeable
palstic Disk 190mm
TVS-79-3573
Pair of spare disks

TVS-79-3572 - 3573



TVS-79-3574 - 215g
with interchangeable
palstic Disk 245mm
TVS-79-3575
Pair of spare disks

TVS-79-3574 - 3575



TVS-79-3576
HAJEK
140g
220mm



TVS-80-3577 - 215g
with interchangeable
plastic Disk 245mm
TVS-80-3578
Pair of spare disks

TVS-80-3577 - 3578



TVS-80-3579 - 140g
HAJEK
140g
220mm



PARTSCH
TVS-80-3580 - 3583
Chisels
140mm

TVS-80-3580 - 3mm
TVS-80-3581 - 4mm
TVS-80-3582 - 5mm
TVS-80-3583 - 6mm



TVS-80-3584 - 2588
GOUGES
140mm

TVS-80-3584 - 4mm
TVS-80-3585 - 6mm
TVS-80-3586 - 8mm
TVS-80-3587 - 10mm
TVS-80-3588 - 12mm



COTTLE
TVS-80-3589 - 2593
Osteotomes with depth
marking
180mm

TVS-80-3589 - 4mm
TVS-80-3590 - 6mm
TVS-80-3591 - 8mm
TVS-80-3592 - 10mm
TVS-80-3593 - 12mm



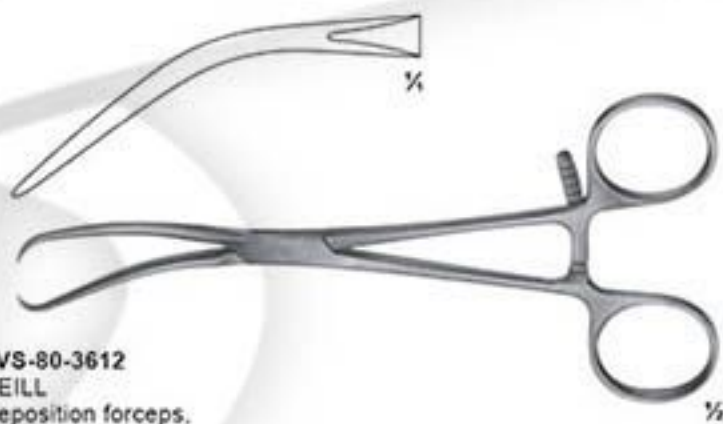
LAMBOTTE
TVS-80-3594 - 2599
Osteotomes, curved
245mm

TVS-80-3594 - 4mm
TVS-80-3595 - 13mm
TVS-80-3596 - 18mm
TVS-80-3597 - 25mm
TVS-80-3598 - 30mm
TVS-80-3599 - 38mm

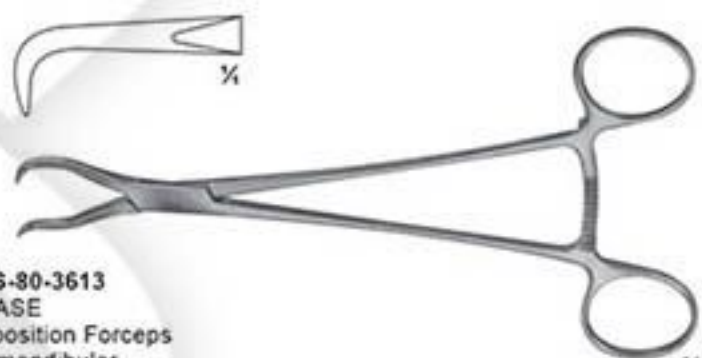


LAMBOTTE
TVS-80-3600 - 2611
Osteotomes
245mm

TVS-80-3600 - 4mm
TVS-80-3601 - 8mm
TVS-80-3602 - 10mm
TVS-80-3603 - 13mm
TVS-80-3604 - 15mm
TVS-80-3605 - 18mm
TVS-80-3606 - 20mm
TVS-80-3607 - 25mm
TVS-80-3608 - 30mm
TVS-80-3609 - 38mm
TVS-80-3610 - 44mm
TVS-80-3611 - 50mm



TVS-80-3612
REILL
Reposition forceps,
170mm



TVS-80-3613
HAASE
Reposition Forceps
for mandibular
Fractures
165mm



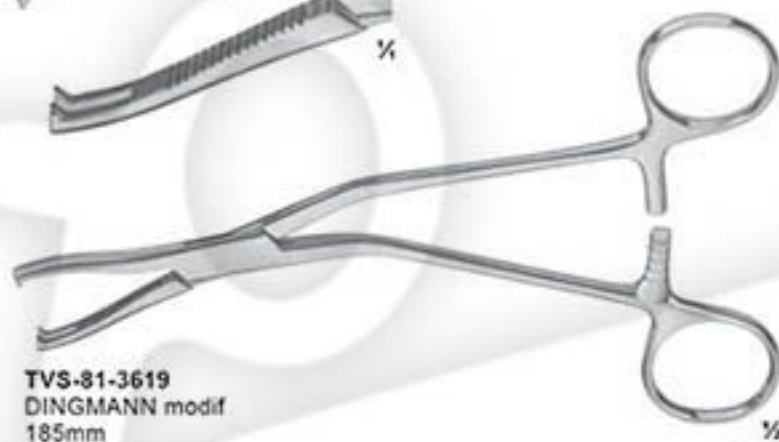
TVS-80-3614
Reposition Forceps,
for small fragments
135mm



TVS-81-3615
MEYER
Reposition forceps
for fingers, with drill
guide for KIRSCHNER
wires up to diam. 1.0mm
170mm



TVS-81-3619
DINGMANN modif
185mm



TVS-81-3616
Reposition forceps
205mm



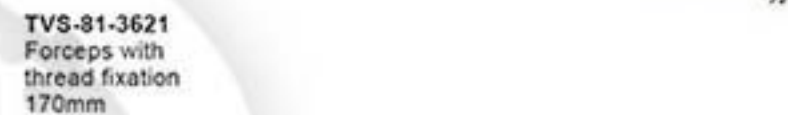
TVS-81-3620
Forceps with
thread fixation
235mm



TVS-81-3617
Patella forceps
185mm



TVS-81-3621
Forceps with
thread fixation
170mm



TVS-81-3618
Forceps with
ratchet fixation
140mm

Laterally
curved



TVS-81-3622
VAN BUREN
Sequester
forceps
225mm



TVS-82-3623
FERGUSSON
205mm



TVS-82-3624
LANGENBECK
205mm



TVS-82-3625
FARABEUF-LAMBOTTE
255mm



TVS-82-3626
FARABEUF
255mm



TVS-82-3627
FARABEUF
230mm



TVS-82-3628
SEMB
190mm



TVS-82-3629
KERN-LANE
240mm



TVS-82-3630
LANE
330mm



TVS-82-3631
KERN-LANE
240mm



TVS-82-3632
HEY GROVES
305mm



TVS-82-3633
LANE
320mm



TVS-83-3634
For small fragments

- TVS-83-3634 - 145mm
- TVS-83-3635 - 190mm
- TVS-83-3636 - 240mm
- TVS-83-3637 - 260mm
- TVS-83-3638 - 280mm

TVS-83-3634 - 3638
Self-centering forceps
with thread fixation



TVS-83-3644
BLUMENTHAL
155mm



TVS-83-3645
LURE
155mm



TVS-83-3639
Fig:1

with lip joint

- TVS-83-3639 - 255mm
- TVS-83-3640 - 265mm
- TVS-83-3641 - 270mm

TVS-83-3639 - 3641
VERBRUGGE



TVS-83-3646
MEAD
165mm



TVS-83-3642
LAMBOTTE
265mm



TVS-83-3647
BEYER
180mm



TVS-83-3643
LUER-FRIEDMANN
145mm



TVS-83-3648 - 3649
BOHLER
155mm

 TVS-84-3651

 TVS-84-3650



TVS-84-3650 - 3651
ECHLIN
230mm



TVS-84-3656
LUER-STILLE
225mm



TVS-84-3652
ROETTGEN-RUSKIN
240mm



TVS-84-3657
LUER-STILLE
225mm



TVS-84-3653
STILLE-RUSKIN
240mm



TVS-84-3658
LOWMAN-GERSTER
210mm



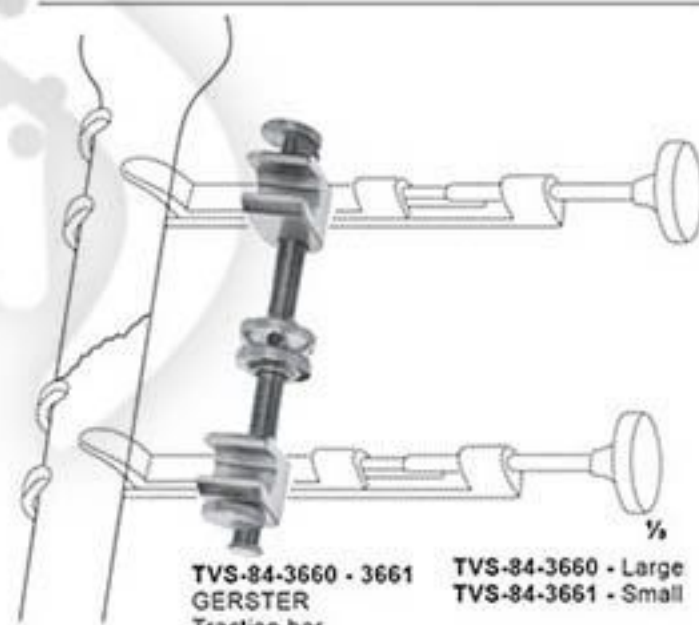
TVS-84-3654
LEKSELL-STILLE
240mm



TVS-84-3659-01 - 85mm
TVS-84-3659-02 - 130mm
TVS-84-3659-03 - 180mm
TVS-84-3659-04 - 205mm
LOWMAN



TVS-84-3655
STILLE
235mm



TVS-84-3660 - 3661
GERSTER
Traction bar
TVS-84-3660 - Large
TVS-84-3661 - Small



TVS-85-3664
170mm

TVS-85-3664 - 3666
LISTON

TVS-85-3665 - 200mm
TVS-85-3666 - 220mm



TVS-85-3674
LISTON
curved on flat
280mm



TVS-85-3667
140mm

TVS-85-3667 - 3670
LISTON

TVS-85-3668 - 170mm
TVS-85-3669 - 200mm
TVS-85-3670 - 220mm



TVS-85-3675
LISTON
Straight
280mm



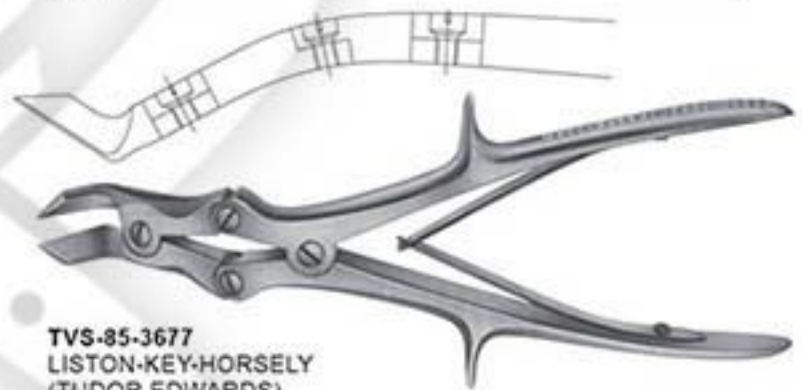
TVS-85-3671
RUSKIN-LISTON
190mm



TVS-85-3676
LISTON
Curved on flat
240mm



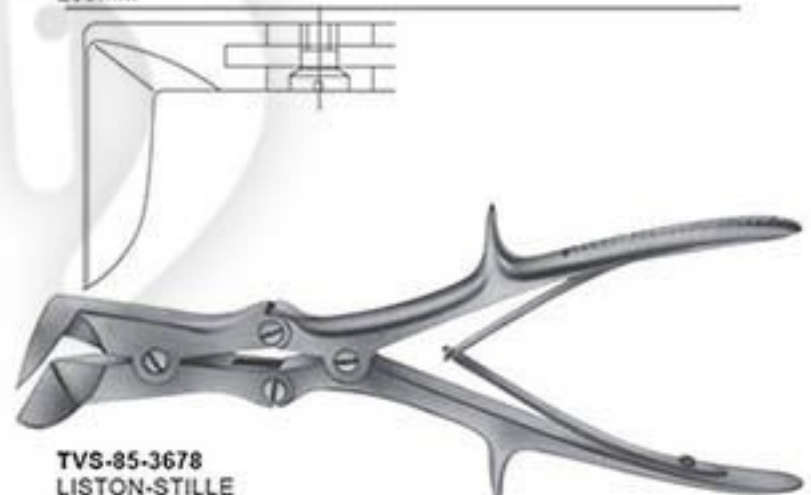
TVS-85-3672
RUSKIN-LISTON
190mm



TVS-85-3677
LISTON-KEY-HORSELY
(TUDOR EDWARDS)
255mm



TVS-85-3673
BOEHLER
140mm



TVS-85-3678
LISTON-STILLE
265mm



TVS-86-3679
WELLER
200mm



TVS-86-3683
MARTIN
205mm



TVS-86-3680
BIRCHER
200mm



TVS-86-3684
BIRCHER-GANSKE
200mm



TVS-86-3681
BIRCHER
200mm



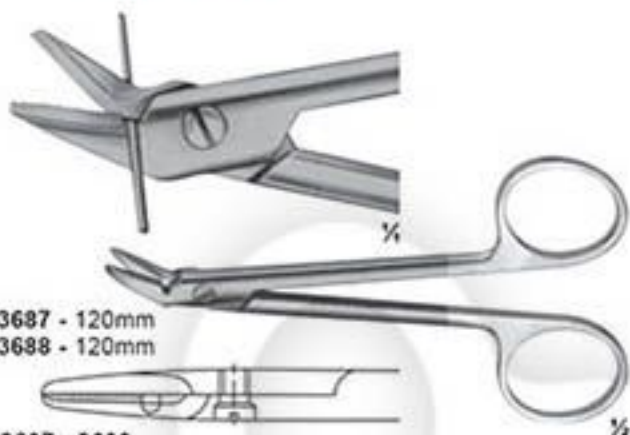
TVS-86-3685
DUROGRIP
Wire, tightening pilres,
ligature pilers
150mm



TVS-86-3682
BIRCHER-GANSKE
200mm

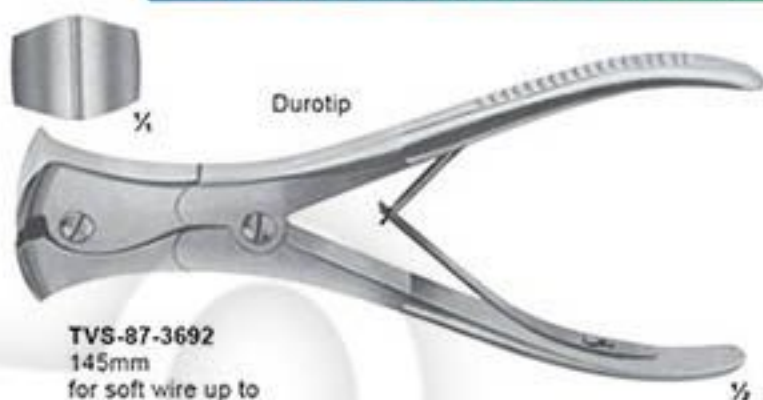


TVS-86-3686
DUROGRIP
Holding forceps for cerclage
wire, with lateral jaws to avoid
wire slipping off
170mm



TVS-87-3687 - 120mm
TVS-87-3688 - 120mm

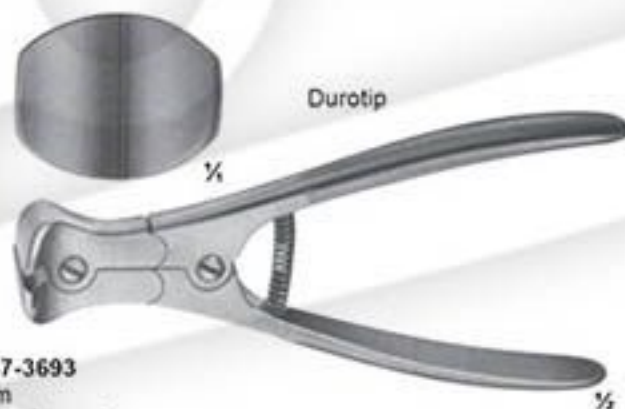
TVS-87-3687 - 3688
DUROTIP



TVS-87-3692
145mm
for soft wire up to
diam. 2.0mm for hard wire
1.5mm upto diam



TVS-87-3689
235mm
for soft wire up to
diam. for hard wire
upto diam

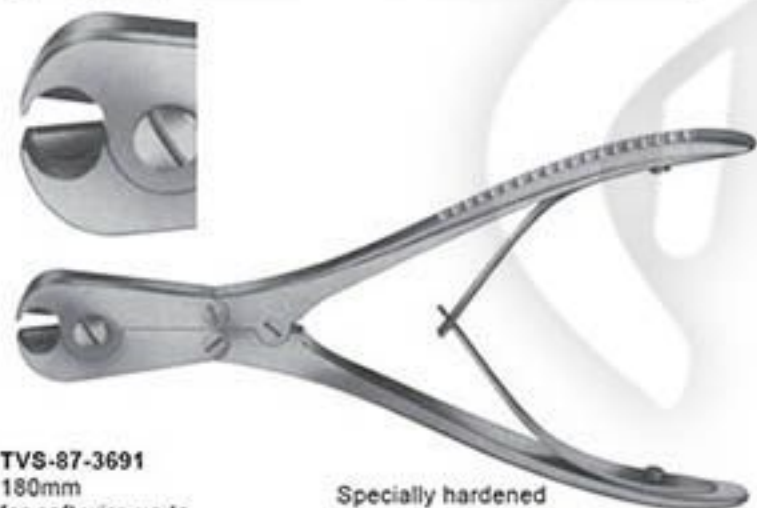


TVS-87-3693
220mm
for soft wire up to
diam. 3.5mm for hard wire
2.5mm upto diam



TVS-87-3690
REILL
175mm
for soft wire up to
diam. 2.0mm for hard wire
1.6mm upto diam

Specially hardened
cutting edges, for
cutting off wires close
to the bone



TVS-87-3691
180mm
for soft wire up to
diam. 2.0mm for hard wire
1.5mm upto diam

Specially hardened
cutting edges. Fornt
and lateral cutting
action

TVS-87-3694
DUROTIP
Cutter for cutting off
KIRSCHNER Wires,
Tibia head screws
bolts, pins, up to 6mm diam.
470mm





Drill points only



TVS-88-3695
Finger nail drill
with 3 drill points

TVS-88-3695 - 3698



TVS-88-3703
STILLE
370mm
TVS-88-3704
Spare blade

TVS-88-3703 - 3704



TVS-88-3699
Nail extracting
forceps
135mm

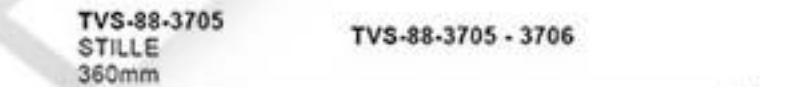


TVS-88-3701
Spare blades



TVS-88-3700
Finger ring saw
150mm

TVS-88-3700 - 3701



TVS-88-3705
STILLE
360mm

TVS-88-3705 - 3706

Plaster saw



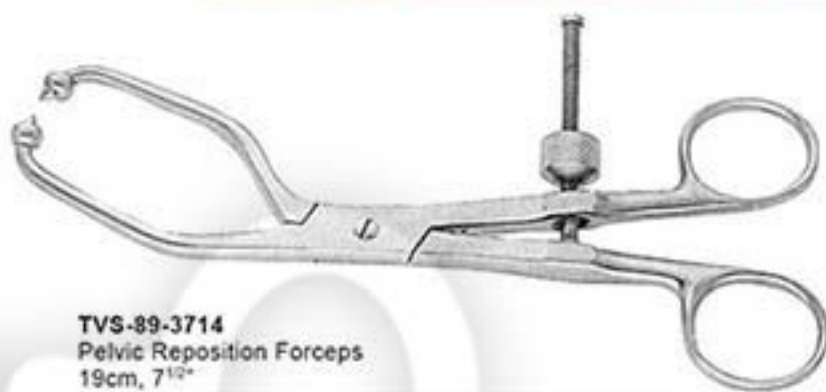
TVS-88-3702
ENGEL
160mm



TVS-88-3707
HENNIG
270mm



TVS-89-3708
Reposition forceps
23cm, 9"



TVS-89-3714
Pelvic Reposition Forceps
19cm, 7^{1/2}"



TVS-89-3709 - 3710
Reposition forceps
With thread lock

TVS-89-3709 - 16cm, 6^{1/2}"
TVS-89-3710 - 24cm, 9^{1/2}"



TVS-89-3715
Pelvic Reposition Forceps
40cm, 15^{3/4}"



TVS-89-3711
Patella Malleolar forceps
21.0cm, 8^{1/4}"



TVS-89-3716
Pelvic Reposition Forceps
40cm, 15^{3/4}"



TVS-89-3717
Pelvic Reposition Forceps
25cm, 10"
3 Balls Spikes



TVS-89-3712
Pelvic Reposition Forceps
25cm, 10"



TVS-89-3718
Pelvic Reduction Forceps Asymmetric
40cm, 15^{3/4}"



TVS-89-3713
Pelvic Reposition Forceps
23cm, 9"



TVS-89-3719
Pelvic Reduction Forceps Asymmetric
25cm, 10"

TVS-90-3720 - 3733



TVS-90-3720
Moor drill & bit sets complete

TVS-90-3721
Still pattern drill set
Complete set of stainless drill
bits and burrs



TVS-90-3735 - 3737
Jacob's Chuck
TVS-90-3735 - T-handle and key
TVS-90-3736 - Only
TVS-90-3737 - key

TVS-90-3738
T-Handle
AO Coupling



TVS-90-3739
Hand Drill
Opening up to
6.35mm



TVS-90-3740 - 28cm 11"
Jacobs
Opening up to
6.35mm



Fig.1
TVS-90-3722
2.5mm



Fig.2
TVS-90-3723
3.0mm



Fig.3
TVS-90-3724
3.5mm



Fig.4
TVS-90-3725
4.0mm



Fig.5
TVS-90-3726
5.0mm



Fig.6
TVS-90-3727
8.0mm



Fig.7
TVS-90-3728
12.0mm



Fig.8
TVS-90-3729
12.0mm



Fig.9
TVS-90-3730



Fig.10
TVS-90-3731
1.0mm



Fig.11
TVS-90-3732
1.5mm



Fig.12
TVS-90-3733
2.0mm



TVS-90-3741
Memoral Head Extrator



TVS-90-3734
Key Handle



TVS-90-3742
T-Handle
For AO Coupling





HEXAGONAL HEAD

	Size of screws	Head Size	Fiber-Handle	AO Coupling	Dental Coupling
A	1.5mm	1.5mm	TVS-91-3743	TVS-91-3746	TVS-91-3749
B	2.0mm				
C	2.7mm	2.5mm	TVS-91-3744	TVS-91-3747	
D	3.5mm				
E	4.0mm	3.5mm	TVS-91-3745	TVS-91-3748	
F	4.5mm				
G	6.5mm				



Wire Guide
TVS-91-3750
70mm



Wire Guide
TVS-91-3751
45mm



Mortising Chisel
TVS-91-3752



Parallel Target Device
TVS-91-3753
for guide wires 2mm



TVS-91-3754
14cm 5^{1/2}"



TVS-91-3755
14cm 5^{1/2}"



TVS-91-3756 - 3757
Perthes
TVS-91-3756 - 18cm 7"
TVS-91-3757 - 21cm 8 1/4"



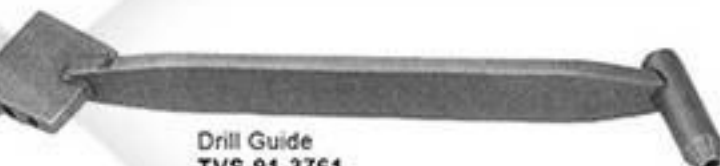
Countersink
TVS-91-3758



Countersink
TVS-91-3759



Countersink
TVS-91-3760



Drill Guide
TVS-91-3761
drill sleeve for 2.0mm
drill bit

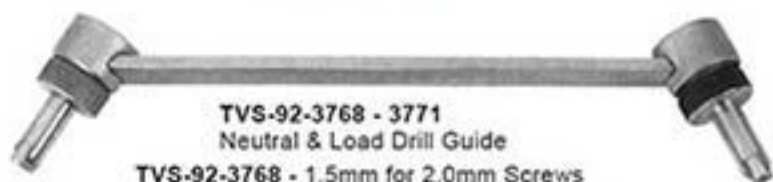


Drill Guide
TVS-91-3762 - 3763

TVS-91-3762
1.1mm and 1.5mm drill bits
TVS-91-3763
1.5mm and 2.0mm drill bits



TVS-91-3764 - 3767
TVS-91-3764 - Tap Sleeve, 2.0mm
TVS-91-3765 - Drill Sleeve, 2.7mm
TVS-91-3766 - Tap Sleeve, 2.5mm
TVS-91-3767 - Drill Sleeve, 3.5mm



TVS-92-3768 - 3771
Neutral & Load Drill Guide
TVS-92-3768 - 1.5mm for 2.0mm Screws
TVS-92-3769 - 2.0mm for 2.7mm Screws
TVS-92-3770 - 2.5mm for 3.5mm Screws
TVS-92-3771 - 3.2mm for 4.5mm Screws



Drill Sleeve
TVS-92-3772
3.2mm for Round
Hole Plates



Tap Sleeve
TVS-92-3773
4.5mm



Tap Sleeve
TVS-92-3774
3.5mm also for used
as 3.2mm drill guide



Tap Sleeve
TVS-92-3775
3.5mm



Drill Pointed Guide
TVS-92-3776
6.5mm



Drill Pointed Guide
TVS-92-3777
6.5mm



Drill Small Pointed
TVS-92-3778
Drill Bit 3.5mm

Insert Drill Sleeve
TVS-92-3779 - 3781

TVS-92-3779 - 2.7 / 2.0mm Drill bits 2.0mm
TVS-92-3780 - 3.5 / 2.5mm Drill bits 2.5mm
TVS-92-3781 - 4.5 / 3.2mm Drill bits 3.2mm



C-Clamp
TVS-92-3782
Drill Guide with thread
for Drill Bit 4.5mm



Drill Guide
TVS-92-3783
3.5mm for neutral
and compression Positioning
Drill Bit 2.5mm



Drill Guide
TVS-92-3784
6.5mm Screws
Drill Bit 3.2mm



Drill Guide
TVS-92-3785
4.5mm Screws
Drill Bit 4.5mm &
3.2mm

Bending Device
TVS-93-3786
21.5cm 8 1/4"
to bend Straight
and angled plates



Plate Bender
TVS-93-3791



Plate Bender
TVS-93-3792



Slotted Hammer
TVS-93-3787
14mm



Plate Bender
TVS-93-3793



Rod Bender
TVS-93-3788
to bend Straight
and angled



Plate Bender
TVS-93-3794



Universal Rod Bender
TVS-93-3789
28.5cm 11 1/4"
to bend Straight
and angled



Plate Bender
TVS-93-3795



Rod Bender
TVS-93-3790
to bend Straight
and angled

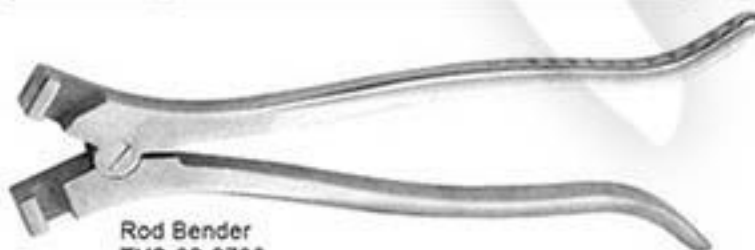


Plate Bender
TVS-93-3796



Plate Bender
TVS-93-3797





TVS-94-3798
18cm, 7"
Wire strainer for
Kirschner wires



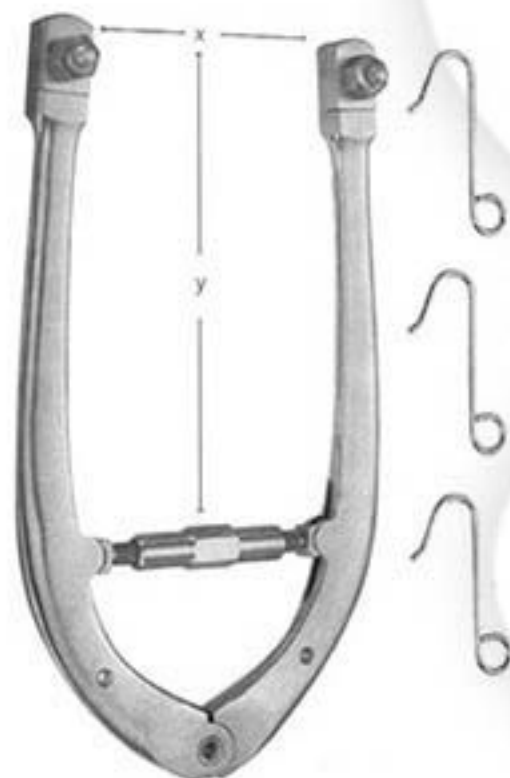
TVS-94-3799 x=95mm y=70mm
TVS-94-3800 x=100mm y=100mm
TVS-94-3801 x=120mm y=120mm
TVS-94-3802 x=155mm y=155mm
TVS-94-3803 x=200mm y=155mm
KIRSCHNER EXTENSION BOWS
with 3 traction hooks



TVS-94-3804 x=130mm
TVS-94-3805 x=185mm
TVS-94-3806 x=220mm
KIRSCHNER EXTENSION BOWS
with 3 traction hooks



TVS-94-3807
WRENCH
KIRSCHNER
EXTENSION BOWS
14mm/17mm



TVS-94-3808 x=180mm y=100mm
TVS-94-3809 x=270mm y=160mm
KIRSCHNER EXTENSION BOWS
with 3 traction hooks



TVS-94-3810 x=75mm y=90mm
TVS-94-3811 x=90mm y=160mm
TVS-94-3812 x=110mm y=210mm
TVS-94-3813 x=150mm y=210mm
BOHLER KIRSCHNER
EXTENSION BOWS
with 3 traction hooks



TVS-94-3814
CHARNLEY-MUELLER
Compression Clamp



SCREW DEPTH GAUGES

- TVS-95-3815 Mini Gauge, 4^{3/4}" Long measures up to 30mm
- TVS-95-3816 Small Gauge, 6^{1/4}" Long measures up to 50mm
- TVS-95-3817 Large Gauge, 8^{3/4}" Long measures up to 100mm
- TVS-95-3818 X-Large Gauge, 11" Long measures up to 120mm



SCREW DEPTH GAUGES

- TVS-95-3819 Mini Gauge, 4^{3/4}" Long measures up to 30mm
- TVS-95-3820 Small Gauge, 6^{1/4}" Long measures up to 50mm
- TVS-95-3821 Large Gauge, 8^{3/4}" Long measures up to 100mm
- TVS-95-3822 X-Large Gauge, 11" Long measures up to 120mm

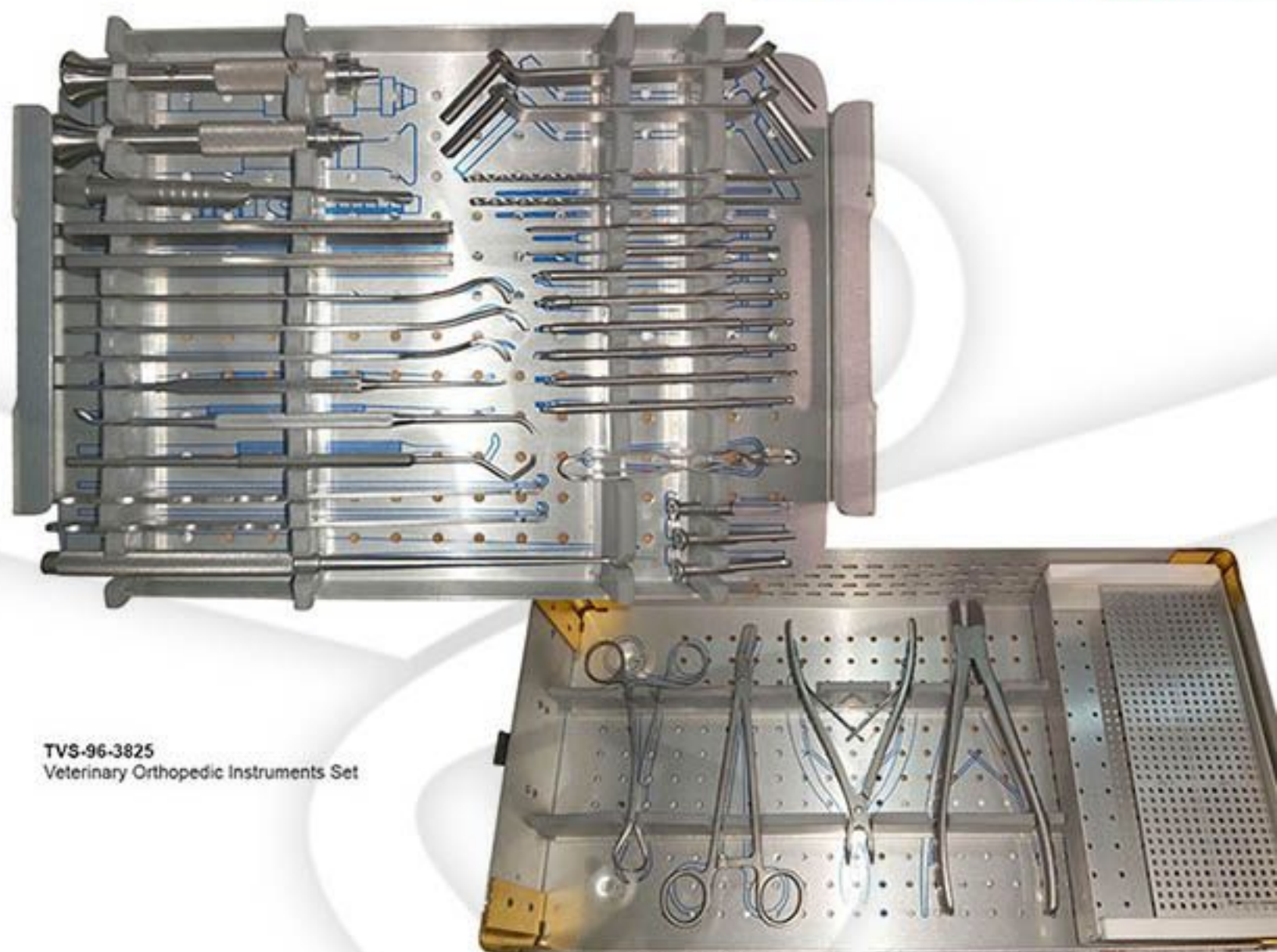


MEASURING GAUGE
TVS-95-3823
For nail

K-Y WIRES
TVS-95-3824

DIAMETER	LENGTH
0.6mm	300mm
0.8mm	300mm
1.0mm	300mm
1.25mm	300mm
1.4mm	300mm
1.6mm	300mm
1.8mm	300mm
2.0mm	300mm
2.5mm	300mm
3.0mm	300mm





TVS-96-3825
Veterinary Orthopedic Instruments Set

TVS-96-3826
Veterinary Orthopedics Instruments Set / Kit 3.5mm/4.0mm

Drill bit 3.2 = 2
 Drill bit 2.5 = 2
 Neutral Loaded Drill Guide 2.5 HA3.5 = 1
 HA3.5 Tap Sleeve 2.5 Drill Guide = 1
 HB4.0 Tap Sleeve 3.0 Drill Guide = 1
 HA3.5 Tap = 1
 HB4.0 Tap = 1
 Depth Gauge = 1
 Hex Head Screw Driver SW2.5 = 1
 Screw Holding Sleeve = 1
 Plate Benders = 1
 Periosteal Elevator (Round Head) = 1
 Periosteal Elevator (Flat Head) = 1
 Reduction Forceps with point = 1
 Reduction Forceps = 1
 Self-centering forceps = 2
 Countersink Drill = 1
 Case (screw rack) 3.5/4.0mm = 1





TVS-97-4000
Westcott Stotch Scissors
very sharp pointed tips,
Standard Blades, Curved



TVS-97-4001
Fine Stitch Scissors
Sharp tips,
medium blades,
curved



TVS-97-4002
Vannas Capsulotomy Scissors
blunt tips, large blades, curved.



TVS-97-4003
Katena Vannas Scissors Sharp
tips, extra thin, 7mm long blades
straight



TVS-97-4004
Colibri Forceps
very delicate,
1x2 teeth, 0.12mm



TVS-97-4005
Castroviejo Colibri Forceps
very delicate,
1x2 teeth 0.12mm



TVS-97-4006
Castroviejo Suturing Forceps
1x2 teeth with typing platform.



TVS-97-4007
Bishop Harmon Dressing Forceps
Criss- Cross Serrated tips.



TVS-97-4008
Bishop Harmon Tissue Forceps
1x2 teeth delicate



TVS-97-4009
Iris Tissue Forceps
1x2 teeth delicate Curved



TVS-97-4010
Iris Tissue Forceps
1x2 teeth delicate Straight



TVS-97-4011
Iris Dressing Forceps
Serrated, delicatated curved.



TVS-97-4012
Iris Dressing Forceps
Serrated, delicatated Straight.



TVS-98-4013
Jewellers Forceps
delicate, Straight #2



TVS-98-4014
Jewellers Forceps
Curved #2



TVS-98-4015
Jewellers Forceps
Angled #5/45.



TVS-98-4016
Hunt Chalazion Forceps round



TVS-98-4017
Chalazion Forceps



TVS-98-4018
Castroviejo Needle Holder
standard jaws, straight with lock.



TVS-98-4019
Castroviejo Needle Holder
delicate jaws, Curved with
lock & without lock.



TVS-98-4020
Jaeger lid Plate



TVS-98-4021
Needle Holder
tungsten carbide
Straight & Curved



TVS-98-4022
Serrefine clamp Small
Straight & Curved



TVS-98-4023
Scissors (TC & Super Cut)
Pointed tip, Straight & Curved



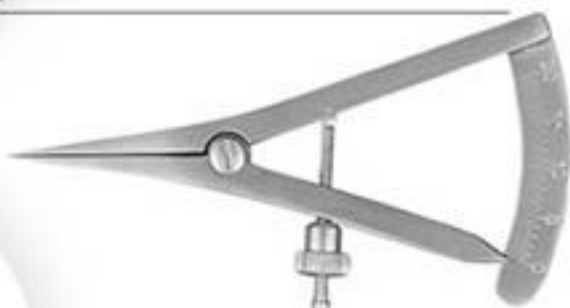
TVS-98-4024-01
Speculum Kratz Barraquer
Angled



TVS-98-4024-02
Speculum Barraquer
Angled Temporal



TVS-98-4025
Strabismus hook



TVS-98-4026
Caliper D Rule



TVS-98-4027
Desmarres Retractor



TVS-98-4028
Air Injection



TVS-98-4029
Lieberman Speculum



TVS-99-5000
ROUND STERILIZER DRUM



TVS-99-5001
Dressing Jar



TVS-99-5002
Instrument Box



TVS-99-5003
Instrument Box



TVS-99-5004
Perforated Box



TVS-99-5005
Instruments Tray



TVS-99-5006
Instruments Tray With Lid



TVS-99-5007
Catheter Tray with Cover



TVS-99-5008
Shallow



TVS-100-5009
Scaler Tray



TVS-100-5010
Perforated Tray



TVS-100-5011
Kidney Tray



TVS-100-5012
Bowls



TVS-100-5013
Wash Basen



TVS-100-5014
Gelipot



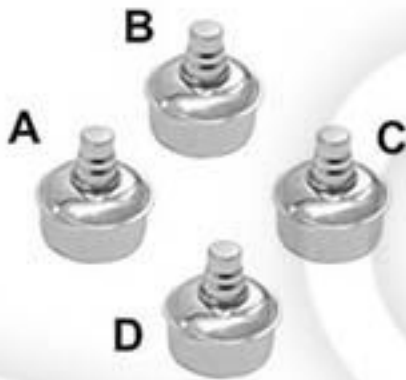
TVS-100-5015
Forceps Jar



TVS-100-5016
Measuring Jug



TVS-100-5017
Cotton Holder



TVS-101-5018
Alcohol Lamp



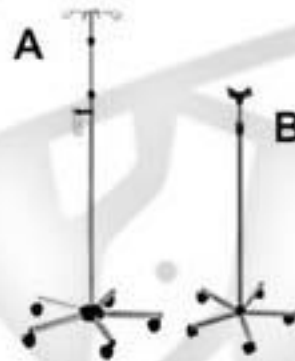
TVS-101-5019
Wire Mesh Basket



TVS-101-5020
Kick Bucket



TVS-101-5021
Bowls Stand



TVS-101-5022
I.V. Stand On Castor



TVS-101-5023
Mayo Table



TVS-101-5024
Soiled Linen Trolley



TVS-101-5025
Dressing Trolley

Eye Surgical Instruments Set TVS-00-5500



TVS-103-5501-01 Veterinary Surgical Instruments Set

TVS-103-5501-02 Set with artificial leather pouch for instruments Storage

TVS-103-5501-03 Set with SS Tray for instruments Storage



TVS-103-5501-A
50x Scalpel Blades



TVS-103-5501-B
1x Scalpel Handle No. 3



TVS-1030-5501-C
1x Snake Hook 21cm



TVS-103-5501-E
1x Adson Dissecting Forceps
12 cm, Serrated



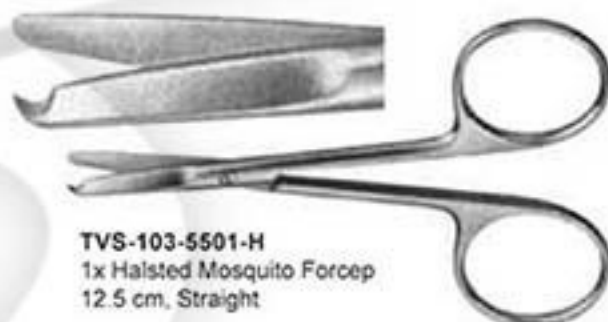
TVS-103-5501-D
1x Metzenbaum Scissors 18 cm, Curved



TVS-103-5501-G
1x Dressing Scissors
14.5cm, Straight



TVS-103-5501-F
1x Adson Tissue Forceps 12cm, 1x2 teeth



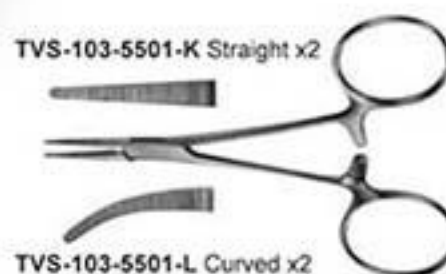
TVS-103-5501-H
1x Halsted Mosquito Forcep
12.5 cm, Straight



TVS-103-5501-I
1x Mayo Hegar Needle Holder 16 cm



TVS-103-5501-J
4x Backhaus Towel Clamps



TVS-103-5501-K Straight x2



TVS-103-5501-M
2x Aliss Tissue Forcep
15 cm



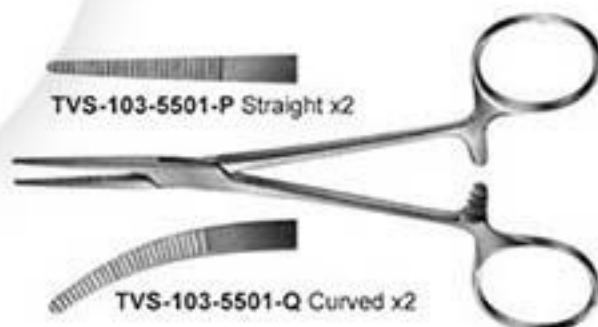
TVS-103-5501-N Straight x1

TVS-103-5501-L Curved x2

TVS-103-5501-K-L
Halsted Mosquito Forcep
12.5 cm, Straight



TVS-103-5501-O Curved x1



TVS-103-5501-P Straight x2

TVS-103-5501-Q Curved x2

TVS-103-5501-N-O Kocher Forcep 14 cm

TVS-103-5501-P-Q Kelly Forcep 14.5 cm

Dissecting kit

TVS-104-5502-01 Dissecting kit with artificial leather pouch

TVS-104-5502-02 Dissecting with SS Tray



TVS-104-5502-A
1x4 Scalpel handle No.4



TVS-104-5502-B
10x Scalpel Blades



TVS-104-5502-E
Artificial Leather Pouch



TVS-104-5502-C
1x Dissecting Forcep 14.5 cm



TVS-104-5502-D
1x Tissue Forcep (1x2) 14 cm



TVS-104-5502-F
1x Dissecting Scissor STR
14.5 cm



TVS-104-5503 DISSECTING KIT

- 1x Tissue Forceps 14.5 cm
- 1x Artry Forceps str 14 cm
- 1x Artry Forceps cvd 14cm
- 1x Splinder Forceps 11 cm
- 1x Scalple Handle No.4
- 1x Dissecting Scissors str 14.5 cm
- 1x Dissecting Scissors cvd 14.5 cm
- 1x Director probe 14 cm
- 1x Blunt ended probe 14 cm



Rodent Dental kit

TVS-105-5504-01 Rodent Dental kit with artificial leather pouch

TVS-105-5504-02 Rodent Dental kit with SS Tray



TVS-105-5504-A
1x Tongue Depressor Large



TVS-105-5504-B
1x Molar & Premolar Serrated Rasp



TVS-105-5504-E
1x Cheek Dilator Small



TVS-105-5504-C
1x Rabbit Mouth gag



TVS-105-5504-F
1x Cheek Dilator Medium



TVS-105-5504-D
1x Friedman Bone Rongeurs 14 cm



TVS-105-5504-G
1x Cheek Dilator Large



TVS-105-5504-H
1x Molar & Premolar Extracting Forceps



TVS-105-5504-I
1x Molar & Premolar Cutting Forceps



TVS-106-5505

Birds Dissecting Kit

- 1x Teaser Needles Straight
- 1x Teaser Needle Cvd
- 1x Iris Scissors 11.5cm
- 1x Scalpel Handle #3
- 1x Adson Micro Forceps 12cm
- 1x Dropper
- 1x Micro Dissection Forceps 12cm Str
- 1x Micro Dissection Forceps 12cm Cvd
- 1x Entomology Forceps 10cm
- 1x Tweezers with Magnifying Mirror
- 1x Stainless Steel Scale 06"
- 4x Blades #10
- 4x Blades #11
- 1x Free Pouch

- TVS-106-5506-01** Dog Dental Scalling kit with artificial leather pouch
- TVS-106-5506-02** Dog Dental Scalling kit with SS Tray

Dog Dental Scalling Kit

- A- Mouth Gag
- B- Dental Explorer
- C- Dog Scalers
- D- Dental Scalers
- E- Dental Tweezers



Winged Elevator Set 8pcs

- TVS-106-5507-01** Winged Elevator Set 8pcs with artificial leather pouch
- TVS-106-5507-02** Winged Elevator Set 8pcs with SS Tray

1x 6mm wing Elevator

1x 1mm Straight tip



1x 2mm Straight tip

1x 5mm wing Elevator

1x 1mm wing Elevator

1x 4mm wing Elevator

1x 2mm wing Elevator

1x 3mm wing Elevator

TVS-107-5508
5pc Luxator Elevator Set

Luxator Elevator 1mm

Luxator Elevator 2mm

Luxator Elevator 3mm

Luxator Elevator 4mm

Luxator Elevator 5mm



TVS-107-5509

Entomology kit for Students
kit Contains:

- 2 Teaser Needle, Straight
- 2 Teaser Needle, Angled
- 1 Iris Scissors, 11.5cm
- 1 Scalpel Handle #3
- 1 Adson Micro Forceps, 12cm
- 1 Dropper
- 2 Micro Dissection Forceps, 12cm, Straight
- 2 Micro Dissection Forceps, 12cm, Curved
- 2 Entomology Forceps, 10cm
- 1 Tweezer With Magnifying Mirror
- 1 Stainless steel Ruler, 6"
- 10 Blades #10
- 1 Instrument Storage Portfolio



TVS-107-5510

Student Botanical Kit

- 1 Scissors, 14cm
- 1 Dropper
- 1 Scalpel Handle #3
- 4 Scalpel Blades
- 1 Teaser Needle, Angled
- 1 Teaser Needle, Stright
- 1 Mariani Tweezers, Angled
- 1 Tweezers, Straight
- 1 Instrument Storage Potfolio

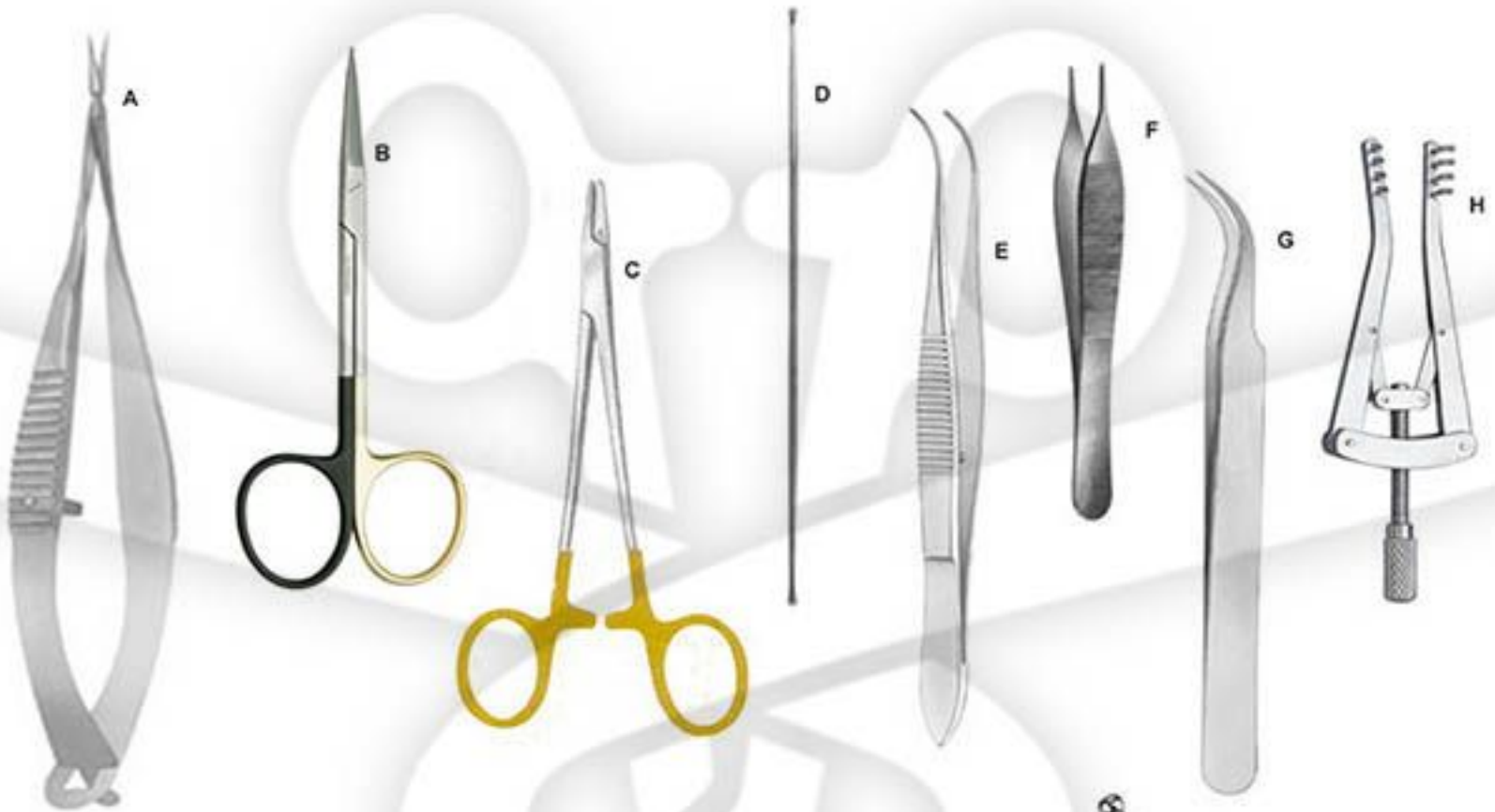


Rat Dissecting Kit

TVS-108-5511-01 Rat Dissecting Kit with artificial leather pouch
TVS-108-5511-02 Rat Dissecting Kit with SS Tray

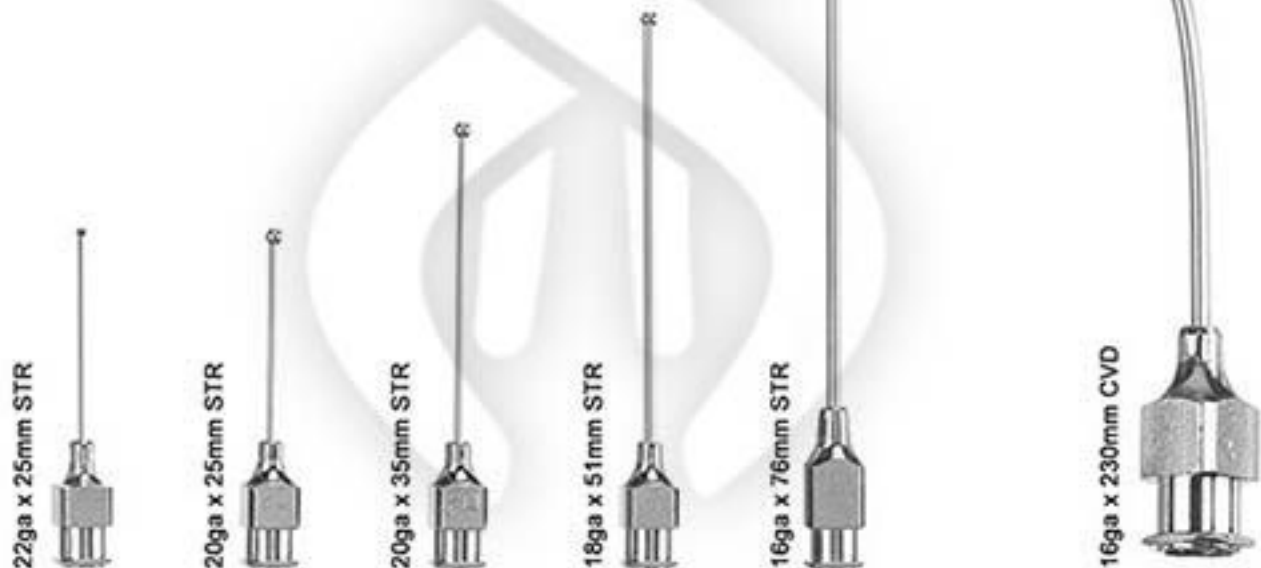
A- 1x Vannas Scissors 08cm
 B- 1x Iris Scissors TC Super Cut 11cm
 C- 1x Mayo Hager Needle Holder 16cm
 D- 1x Blunt Probe

E- 1x Iris Forceps 11.5cm
 F- 1x Adson Micro Forceps 12cm
 G- 1x Micro Forceps 12cm
 H- 1x Alm Retractor 7cm 4x4



Rodent Feeding Needle Sets of 6pcs

TVS-108-5512-01 Rodent Feeding Needle Sets with artificial leather pouch
TVS-108-5512-02 Rodent Feeding Needle Sets with SS Tray





GENERAL SURGERY SET

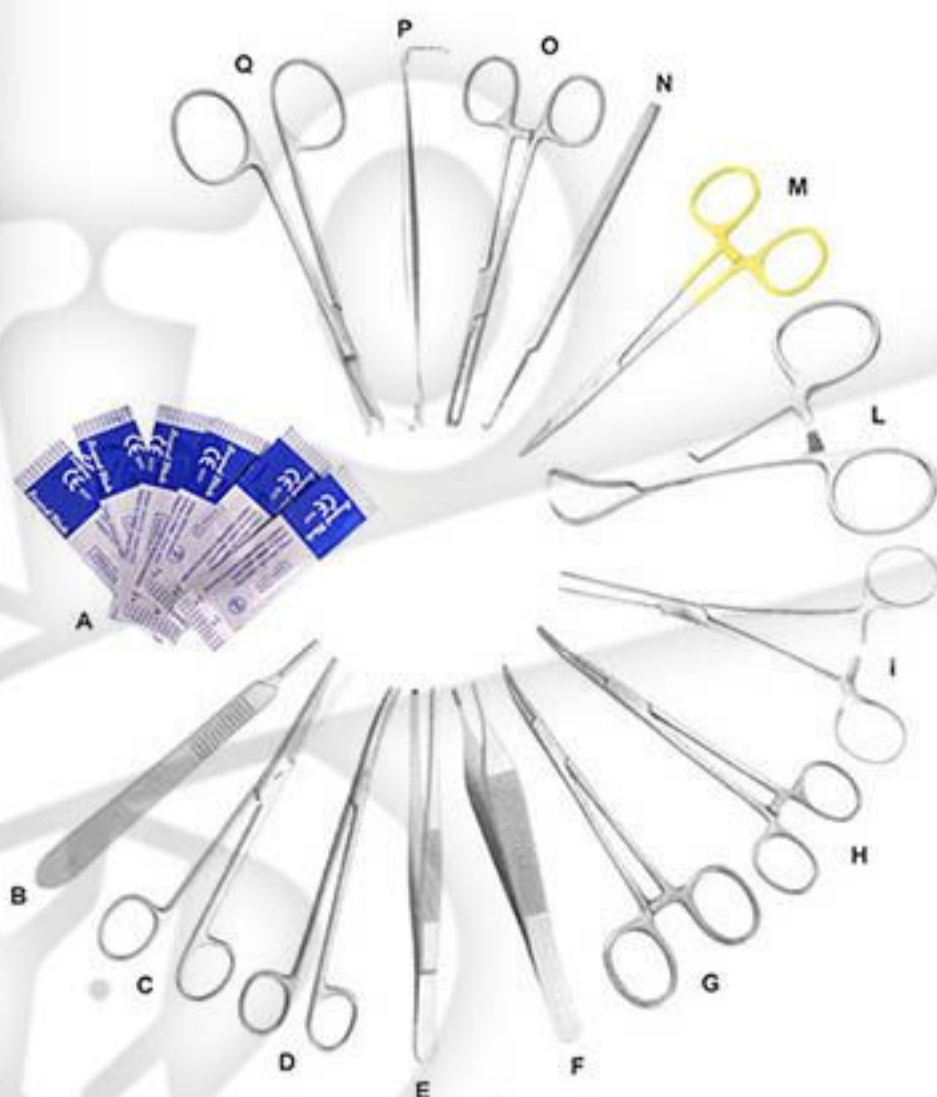
TVS-109-5513-01

General Surgery set with artificial leather pouch

TVS-109-5513-02

General Surgery set with SS Tray

- A- 50 X Scalpel Blades
- B- 1 x Knife handle No. 3
- C- 1 x Mayo Scissor Straight 17 cm,
- D- 1 x Metzenbaum Scissor 18 cm, Curved
- E- 1 x Tissue Forcep 14 cm, (Toothed)
- F- 1 x Adson Brown Forcep 12 cm, (Toothed)
- G- 1 x Halsted Mosquito Forcep 12.5 cm, Curved
- H- 1 x Kelly Forcep 14 cm, Curved
- I- 1 x Rochester Carmalt Forcep 16cm, Curved
- J- 4 x Backhaus Towel Clamp 9 cm
- K- 1 x Tungsten Carbide Olsen Hegar Needle Holder 14 cm
- L- 1 x Snake Hook
- M- 1 x Aliss Tissue Forcep 15 cm,
- N- 1 x Senn Miller Retractor
- O- 1 x Suture Scissor 14 cm,



TVS-109-5514-01

General Surgery set with artificial leather pouch

TVS-109-5514-02

General Surgery set with SS Tray

- A- 4 x Rochester Carmalt Forcep 16cm, Str & Cvd
- B- 1 x Tungsten Carbide Olsen Hegar N/H 14.5 cm
- C- 4 x Backhaus Towel Clamps 13 cm
- D- 2 x Kelly Hemostat 14 cm, Curved
- E- 1 x TC Mayo Scissors, Straight 14.5 cm
- F- 1 x Scalpel Handle No. 3
- G- 50x Scalpel Blades
- H- 1 x Snake Hook 21 cm
- I- 1 x Adson Brown Forceps 7x7 12 cm
- J- 3 x Mosquito Forcep 12.5 cm, curved
- K- 1 x Tungsten Carbide Metzenbaum Scissors 18cm curved



CANINE / FELINE SPAY KIT

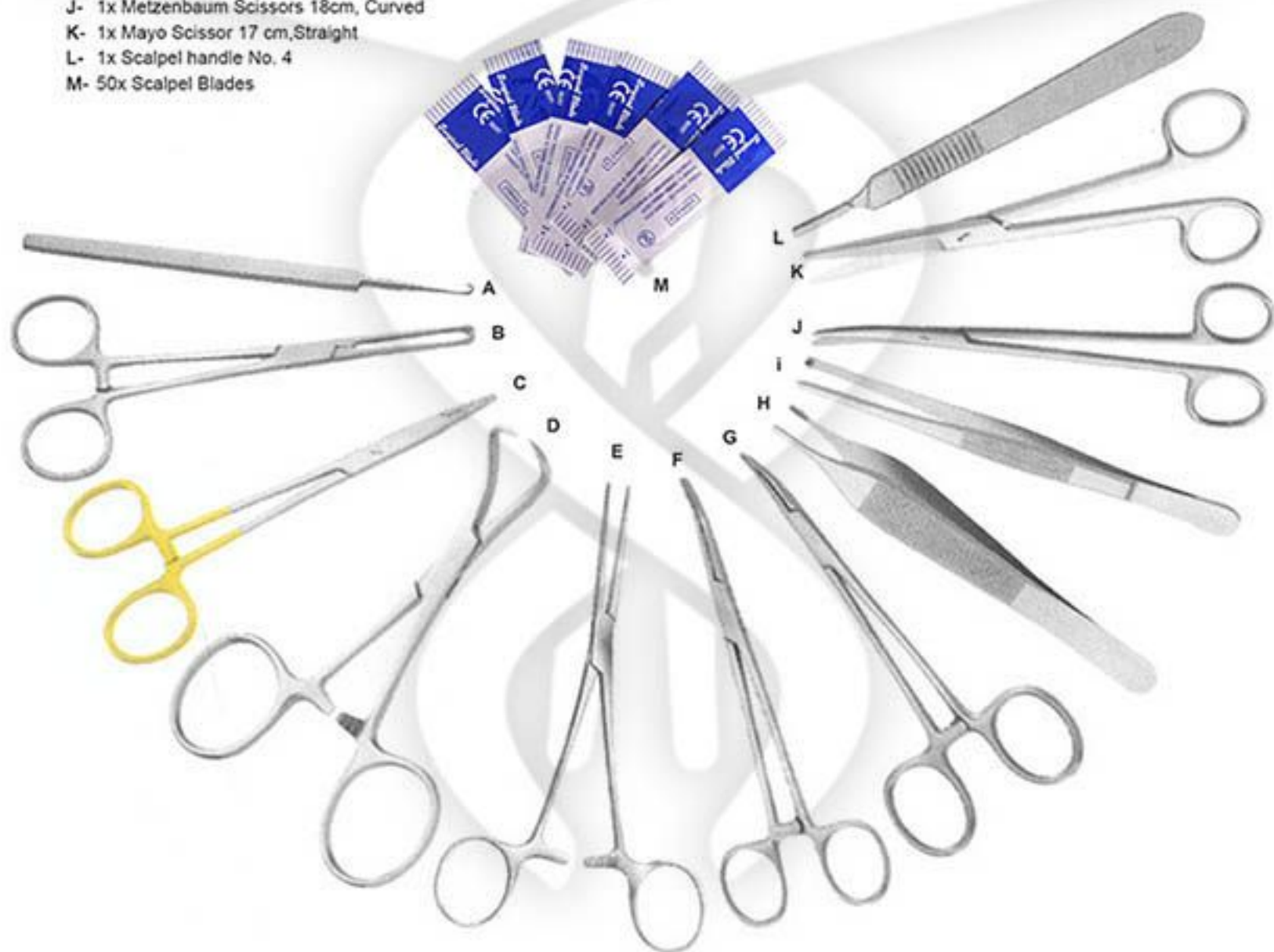
TVS-110-5515-01

Canine / Feline SPAY KIT with artificial leather pouch

TVS-110-5515-02

Canine / Feline SPAY KIT with SS Tray

- A- 1x Snake Hook
- B- 1x Aliss Tissue Forcep 15 cm
- C- 1x Tungsten Carbide Olsen Hegar N/H 14.5 cm
- D- 4x Backhaus Towel Clamp 10 cm
- E- 4x Rochester Carmalt Forcep 16cm Str & Curv
- F- 2x Kelly Forcep 14cm Curved
- G- 2x Mosquito Forcep 12.5 cm Curved
- H- 1x Adson-Brown Forceps 12 cm, 7x7
- I- 1x Tissue Forcep 16cm 1x2teetj
- J- 1x Metzenbaum Scissors 18cm, Curved
- K- 1x Mayo Scissor 17 cm, Straight
- L- 1x Scalpel handle No. 4
- M- 50x Scalpel Blades



STADNARD VETERINARY EYE INSTRUMENT SET

TVS-111-5516-01

Stadnard Veterinary Eye Instrument Set with artificial leather pouch

TVS-111-5516-02

Stadnard Veterinary Eye Instrument Set with SS Tray

- A- 50 x Scalpel Blades
- B- 1 x Scalpel Handle No. 3
- C- 1 x Wire Speculum
- D- 1 x Eye Dressing Forcep 10 cm
- E- 1 x Chalazion Forcep 9 cm
- F- 1 x Steven Tenotomy Scissor 12 cm
- G- 1 x Castroviejo Needle Holder 14cm.
- H- 1 x Bishop Harman Tooth Forcep 9 cm
- I- 1 x Tungsten Carbide Oosen Hegar Needle Holder 14 cm
- J- 1 x Desmarres Retractor 14 cm



ABDOMINAL PACK

TVS-111-5517-01

Abdominal pack with artificial leather pouch

TVS-111-5517-02

Abdominal pack with SS Tray

- A- 1 X Poole Suction Tube
- B- 1 X Olsen Hegar Needle Holder 18 cm.
- C- 1 x Metzenbaum Scissors 18 cm
- D- 1 x Doyen Intestinal Clamp 25 cm
- E- 1 x Debakey Forcep 15 cm
- F- 1 x Central Blade For Balfour
- G- 1 x Balfour Retractor Large
- H- 1 x Baby Balfour Retractor with Central Blades



VETERINARY ORTHOPEDIC INSTRUMENTS SET

TVS-112-5518-01

Veterinary orthopedic instruments set with artificial leather pouch

TVS-112-5518-01

Veterinary orthopedic instruments set with SS Tray

- A- 1 x Wire Cutting Scissor 12cm
- B- 1 x Senn Miller Retractor 16cm, Blunt Prongs, D/E
- C- 1 x Senn Miller Retractor 16cm, Sharp Prongs, D/E
- D- 1 x Weitlaner Retractor 13 cm
- E- 1 x Free Elevator 18cm, D/E, Si/B Blades
- F- 1 x Mallet (Hammer)
- G- 1 x Bone File
- H- 1 x TC Needle Holder 16 cm, (Cruciate)
- I- 1 x Kern Bone Holding Forceps 16 cm
- J- 1 x Kern Bone Holding Forcep 23cm
- K- 1 x Bone Cutting Forcep
- L- 1 x Pin Cutter
- M- 1 x Osteotome



VETERINARY ORTHOPEDIC INSTRUMENT SET

TVS-112-5519-01

Veterinary orthopedic instruments set with artificial leather pouch

TVS-112-5519-01

Veterinary orthopedic instruments set with SS Tray

- Reduction Forceps, with serrated jaw, 240 mm, speed lock
- Hohmann Retractor, 43 mm width, narrow tip
- Hohmann Retractor, 22 mm width, wide tip
- Hammer, 500 grams
- Chisel Handle
- Chisel Blade, 10 mm
- Chisel Blade, 16 mm
- Chisel Blade, 25 mm
- Reduction Forceps, with points, 205 mm, ratchet



TVS-112-5520-01

Reduction Instruments set with artificial leather pouch

TVS-112-5520-02

Reduction Instruments set with SS Tray

- Plate Holding Forceps with swivel foot, size 0
- Reduction Forceps, 180 mm length, speed lock
- Hohmann Retractor, 18 mm width, short narrow tip, 2 ea.
- Periosteal Elevator, 14 mm width, curved blade, round edge
- Reduction Forceps, with points, 130 mm length, ratchet
- Reduction Forceps, with points, 205 mm length, ratchet





CRUCIATE PACK SET

TVS-113-5521-01

Cruciate Pack set with artificial leather pouch

TVS-113-5521-02

Cruciate Pack set with SS Tray

A- 1x Hohmann Retractor

B- 1x Mini Hohmann Retractor

C- 1x Menisectomy Knife

D- 2x Deschamps Needle Right Small & Large

E- 1x Martin Cartilage Forceps 10 cm

F- 1x Gelpi Retractor 11 cm



VETERINARY OSTEOTOME KIT

TVS-113-5522-01

Veterinary Osteotome Kit with artificial leather pouch

TVS-113-5522-02

Veterinary Osteotome Kit with SS Tray

A- 1x Lambotte Osteotome 7" Straight 6mm

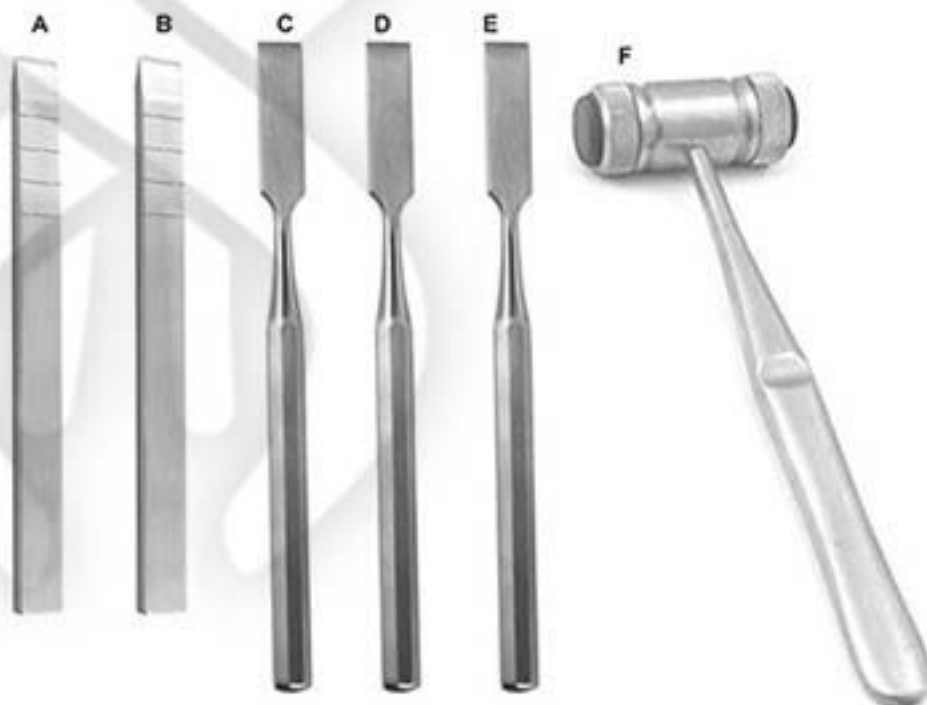
B- 1x Lambotte Osteotome 7" Straight 12mm

C- 1x Hoke Osteotome 9.5" Straight 06mm

D- 1x Hoke Osteotome 9.5" Straight 13mm

E- 1x Hoke Osteotome 9.5" Straight 19mm

F- 1x Mead Mallet 7.5" (315gm)



ORTHOPEEDIC KNEE PACK SET

TVS-114-5523-01

Orthopedic Knee Pack set with artificial leather pouch

TVS-114-5523-02

Orthopedic Knee Pack set with SS Tray

A- 1 x Mini-Hohmann 16 cm, Width 6 mm

B- 1 x Mini-Hohmann 16 cm, Width 8 mm

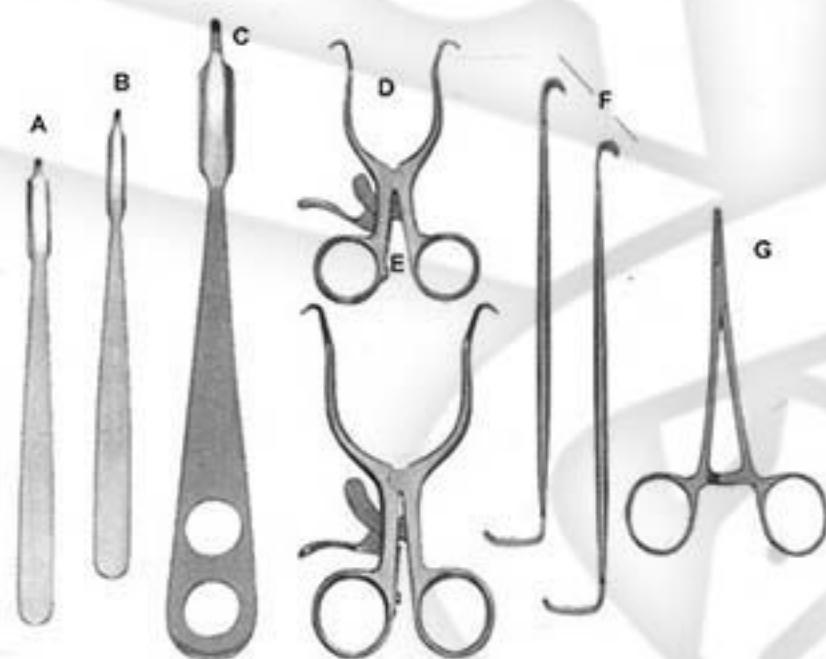
C- 1 x Hohmann 16 cm, Width 12 mm

D- 1 x Gelpi Retractor 11.5 cm, Sh/Cvd

E- 1 x Gelpi Retractor 11.5 cm, Sh/Cvd

F- 2 x Senn Miller Retractor 16 cm

G- 1 x Halsted Mosquito Forcep 12.5 cm, 1x2teeth, Cvd



SPAYING & TEAT INSTRUMENTS

TVS-114-5524-01

Spaying & Teat Instruments with artificial leather pouch

TVS-114-5524-02

Spaying & Teat Instruments with SS Tray

A- 1 x Covalt Ovarlectomy Hook with Probe tip 21cm

B- 1 x Snake Ovarlectomy Hook 20cm,

C- 1 x Snake ovarlectomy Hook 20 cm

D- 1 x Udally Teat Bistouri 16cm, Blunt

E- 1 x Lichty Teat Bistouri 14 cm, Sharp Point

F- 1 x Lighty Teat Bistouri 14 cm Blunt Point

G- 1 x Cornell Teat Curette 16cm,

H- 1 x Bower Obstetrical Forceps 24.5 cm, Straight

I- 1 x Bower Obstetrical Forceps 24.5 cm, Curved





CANINE PERIODONTAL SET

TVS-115-5525-01

Canine Periodontal set with artificial leather pouch

TVS-115-5525-02

Canine Periodontal set with SS Tray

A- 1xMirror Handle Cone Socket

B- 1xMouth Mirro No 4

C- 1xExplorer 2

D- 1xProbe 20-23 Explorer

E- 1xCurette Columbia 13-14 fine

F- 1xCurette Columbia 41-4r

G- 1xSnook Ovarlectomy Hook



NEUTER PACK SET

TVS-115-5526-01

Neuter Pack set with artificial leather pouch

TVS-115-5526-01

Neuter Pack set with SS Tray

A- 4 x Scalpel Blades

B- 1 x Scalpel Handle NO.3 with Scale Graduated

C- 1 x Adsong Tissue Forcep 12cm, 1x2 teeth

D- 1 x Metzenbaum Scissors 18 cm,

E- 1 x TC Olsen Hegar Needle Holder 14.5 cm

F- 4 x Backhaus Towel Clamp 13 cm

G- 1 x Aliss Tissue Forcep 15cm

H- 1 x Tc Crile Wood Needle Holder 15 cm

I- 1 x Halsted Mosquito Forcep 12.5 cm,



CANINE & FELINE TRATER SCRAPERS

TVS-116-5527-01

Canine & Feline Trater Scrapers set with artificial leather pouch

TVS-16-5527-02

Canine & Feline Trater Scrapers set with SS Tray

- A- 1xTartar Scraper Claw Type
- B- 1xTartar Scraper Curved with Straight Edge
- C- 1xTartar Scraper Angular, Pointed
- D- Tartar Scraper Triangular
- E- 1xTartar Scraper Curved with Angled Edge
- F- 1xTartar Scraper DE Cvd with Angled Edge
- G- 1xUnicursal Scaler #12, Double Ended,solid
- H- 1xTowner Scaler #15, Single Ended Solid
- I- 1xTowner Scaler #15/33,Double Ended,Solid
- J- 1xUnicursal Scaler #32, Single Ended, Solid
- K- 1xUnicursal Scaler #33, Single Ended, Solid
- L- 1xUnicursal Scaler #34, Single Ended, Solid
- M- 1xTaratar Remover 11cm, Small
- N- 1xTartar Remover 14 cm, Large



BASIC PROPHYLAXIS SETUP SET

TVS-116-5528-01

BAasic Prophylaxis setup set with artificial leather pouch

TVS-116-5528-01

BAasic Prophylaxis setup set with SS Tray

- A- 1xMouth Mirror #4 with Handle
- B- 1xMccall Scaler
- C- 1xproble/Explorer
- D- 1xJacquette Scaller
- E- 1xTowner-jacquette Scaller





VETERINARY PERIODONATAL BASIC KIT

TVS-117-5529-01

Veterinary periodontal Basic kit with artificial leather pouch

TVS-117-5529-01

Veterinary periodontal Basic kit with SS Tray

- A- 1xMouth Mirror with Hadrile
- B- 1xProbe/Explorer cp 12/23
- C- 1xTowner Jaquette Scaler
- D- 1xGracey Anterior Curette
- E- 1xCurette H6/H7 Scaler
- F- 1xColumbia Curette
- G- 1xDental Elevator 2mm Tip
- H- 1xDental Elevator 2.5 mm Tip
- I- 1xDental Elevator 3 mm Tip





RODENT PACK SET

- TVS-118-5530-01**
Rodent Pack set with artificial leather pouch
- TVS-118-5530-02**
Rodent Pack set with SS Tray
- A-** 3xCheek Retractors (Small,Medium,Large)
- B-** 1xRabit Mouth Gag
- C-** 1xTooth Cutter
- D-** 1xTooth Extracting Forceps
- E-** 1xSpatula
- F-** 1xMolar Luxator Elevator 3mm Tip
- G-** 1xMolar Luxator Elevator 5 mm Tip
- H-** 1xDental Curette



TVS-118-5531
Fish Aquarium Set



TVS-118-5532
Fish Aquarium Set



DENTAL PACK SET

TVS-119-5533-01

Dental Pack Set with artificial leather pouch

TVS-119-5533-01

Dental Pack Set with SS Tray

A- 1xWinged Elevator Set of 4 Pcs

B- 1xDental Extracting Forceps Set of 2 Pcs

C- 1xRoot Elevator 78N

D- 1xExplorer Double Ended

E- 1xCurettes Columbia 13-14

F- 1xCurettes Columbia 4L-4R

G- 1xScaler Jacquette 2s-3s

H- 1xFreer Elevator

I- 1XTC Needle Holder 18 cm





Bonkan Road, Pacca Garrah
Sialkot 51310, Punjab, Pakistan

Tel: +92 52 429 5908

Fax: +92 52 435 2475

Cell: +92 334 111 2411, 315 111 2411

What'sapp +92 321 613 8119

Email: inquiry@talcindustries.com

Web: www.talcindustries.com



ISO
9001-2015
13485-2016



This Catalogue is
Designed & Printed by **PrintSoLS**
www.printsols.com +92 52 4593200

www.talcindustries.com